

A 5x4 grid of squares. The top row is white, the second row is light blue, the third row is medium blue, the fourth row is dark blue, and the bottom row is a very dark blue. The text 'SPOT DOWNLIGHT' is written in white, bold, italicized capital letters across the bottom row.



SPOT DOWNLIGHT



CLEAR GLASS

120.-

DIA 49 mm. H 3 mm.



 Clear glass
 For MR16 lamp



FROSTED GLASS

120.-

DIA 49 mm. H 3 mm.

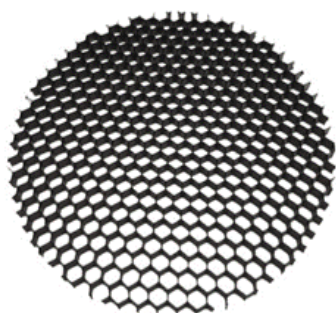

 Frosted glass
 For MR16 lamp



HONEYCOMB

120.-

DIA 50 mm. H 3 mm.

 Aluminium material
 For MR16 lamp

ACCESSORIES



MR11 MODULE 6W

800.-

2700K, 3000K, 4000K



CREE CHIP LED 6W 480lm



Aluminium Body

LED Driver included

Non-Dim

Dimmable (0-10V/ Triac) Optional

MR11 MODULE 10W

1000.-

2700K, 3000K, 4000K



CREE CHIP LED 10W 770lm



Aluminium Body

LED Driver included

Non-Dim

Dimmable (0-10V/ Triac) Optional



MR11 MODULE 15W

1500.-

2700K, 3000K, 4000K



CREE CHIP LED 15W 1350lm



Aluminium Body

LED Driver included

Non-Dim

Dimmable (0-10V/ Triac) Optional

LED LAMP



MR16 MODULE 10W 1000.-

2700K, 3000K, 4000K, 6000K



CREE CHIP LED 10W 800lm

15° 24° 36° 60°



Aluminium Body
LED Driver included
Non-Dim
Dimmable (0-10V/ Triac) Optional

MR16 MODULE 15W 1500.-

2700K, 3000K, 4000K, 6000K



CREE CHIP LED 15W 1200lm

15° 24° 36° 60°



Aluminium Body
LED Driver included
Non-Dim
Dimmable (0-10V/ Triac) Optional



MR16 MODULE 20W 2000.-

3000K, 4000K, 6000K



CREE CHIP LED 20W 1600lm

12° 24° 36°



Aluminium Body
LED Driver included
Non-Dim
Dimmable (0-10V/ Triac) Optional

LED LAMP



MR16 MODULE 8W CCT 1500.-

2700K to 6500K



LED CHIP LED 24Vdc 8W

38°



Aluminium Body

Dimmable

Use with LED controller

Use with 24Vdc power supply

MR16 MODULE 8W RGBW 1500.-

RGB+2700K



LED CHIP LED 24Vdc 8W

38°



Aluminium Body

Dimmable

Use with LED controller

Use with 24Vdc power supply



LED MR16 7W

400.-

2700K, 3000K, 4000K, 6000K



EPISTAR CHIP LED 7W 560lm

15° 60°

- Aluminium Body
- Non-Dim
- Dimmable (Optional)



LED GU10 7W

400.-

2700K, 3000K, 4000K, 6000K



EPISTAR CHIP LED 7W 560lm

15° 24° 60°

- Aluminium Body
- Non-Dim
- Dimmable (Optional)



AR111 MODULE 15W 1500.-

3000K, 4000K, 6000K.



CREE CHIP LED 15W 1200lm

24°

- Aluminium Body
- LED Driver included
- Non-Dim
- Dimmable (0-10V/ Triac) Optional

AR111 MODULE 30W 2250.-

3000K, 4000K, 6000K



CREE CHIP LED 30W 2700lm

24°

- Aluminium Body
- LED Driver included
- Non-Dim
- Dimmable (0-10V/ Triac) Optional



LED LAMP

LED PAR30L 15W

700.-

3000K, 4000K, 6000K



SMD CHIP LED 15W 1350lm

25°



Non-Dim



LED PAR30L 30W

1000.-

3000K, 4000K, 6000K



SMD CHIP LED 30W 2700lm

25°



Non-Dim





DOWNLIGHT



LUNA-RA MR11

300.-

DIA 50 mm. H 45 mm.

 LED Module MR11
 Matt white trim



IP 20

 Adjustable
Matt white reflector

LUNA-RE

300.-

DIA 50 mm. H 45 mm.

 LED Module MR11
 Matt black trim

IP 20

 Adjustable
Matt black reflector





DOWNLIGHT



BENN-RA MR11

300.-

DIA 65 mm. H 45 mm.

 LED Module MR11
 Matt white trim



IP 20

 Adjustable
Matt white reflector

BENN-SA

300.-

DIA 65x65 mm. H 45 mm.

 LED Module MR11
 Matt white trim

IP 20

 Adjustable
Matt white reflector



DOWNLIGHT



ALIS-RW MR11

350.-

DIA 65 mm. H 28 mm.

 LED Module MR11
Matt white trim

IP 20

 Adjustable
Matt black reflector

ALIS-RB MR11

350.-

DIA 65 mm. H 28 mm.

 LED Module MR11
Matt black trim

IP 20

 Adjustable
Matt black reflector



DOWNLIGHT



JUNI-WH MR11

300.-

DIA 65 mm. H 35 mm.

 LED Module MR11
Matt white trim

IP 20

 Fixed
Matt black reflector

JUNI-BK MR11

300.-

DIA 65 mm. H 35 mm.

 LED Module MR11
Matt black trim

IP 20

 Fixed
Matt black reflector

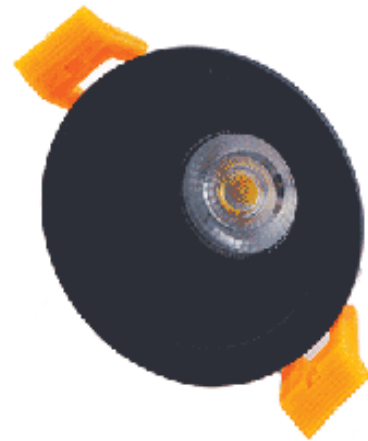



DOWNLIGHT



ALIS-SW1 MR11

350.-

DIA 65x65 mm. H 45 mm.

 LED Module MR11
 Matt white trim



IP 20

 Adjustable
Matt black reflector

ALIS-SW2 MR11

500.-

DIA 65x121 mm. H 45 mm.

 LED Module MR11
 Matt white trim

IP 20

 Adjustable
Matt black reflector





DOWNLIGHT



ALIS-SB1 MR11

350.-

DIA 65x65 mm. H 45 mm.

 LED Module MR11
 Matt black trim



IP 20

 Adjustable
Matt black reflector

ALIS-SB2 MR11

500.-

DIA 65x121 mm. H 45 mm.

 LED Module MR11
 Matt black trim

IP 20

 Adjustable
Matt black reflector



DOWNLIGHT



RIT-A

400.-

DIA 100 mm. H 56.5 mm.

MR16x1/ GU10/ LED Module
Sand white/ Sand black trim

IP 20

- Fully adjustable
Accessories : Honeycomb, Frosted glass
Clear glass

RIT-B

400.-

DIA 92x92 mm. H 56.5 mm.

MR16x1/ GU10/ LED Module
Sand white/ Sand black trim

IP 20

- Fully adjustable
Accessories : Honeycomb, Frosted glass
Clear glass



RIT-2B

800.-

DIA 92x185 mm. H 56.5 mm.

MR16x2/ GU10/ LED Module
Sand white/ Sand black trim

IP 20

- Fully adjustable
Accessories : Honeycomb, Frosted glass
Clear glass

DOWNLIGHT



HYBRID-RS

400.-

DIA 78 mm. H 75 mm.

MR16x1/ GU10
Sand white trim

IP 20

- Fully adjustable
Black reflector (anti glare)
Accessories : Honeycomb, Frosted glass
Clear glass

HYBRID-RM

600.-

DIA 95 mm. H 108 mm.

MR16x1/ GU10
Sand white trim

IP 20

- Fully adjustable
Black reflector (anti glare)
Accessories : Honeycomb, Frosted glass
Clear glass

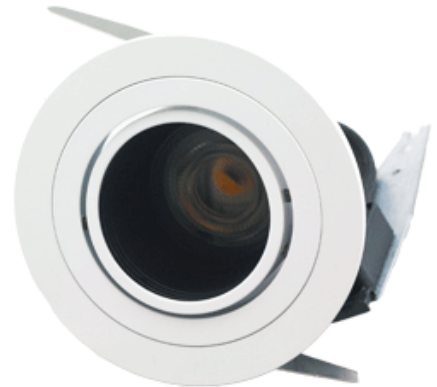
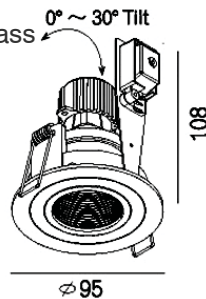

HYBRID-SM

600.-

DIA 95x95 mm. H 108 mm.

MR16x1/ GU10
Sand white trim

IP 20

- Fully adjustable
Black reflector (anti glare)
Accessories : Honeycomb, Frosted glass
Clear glass

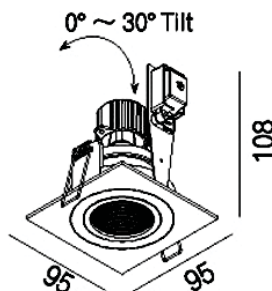

DOWNLIGHT

EZY-RA

390.-

DIA 80 mm. H 50 mm.

MR16x1/ GU10/ LED Module
Matt white trim

IP 20

- Adjustable
Matt white reflector
Accessories : Honeycomb, Frosted glass
Clear glass

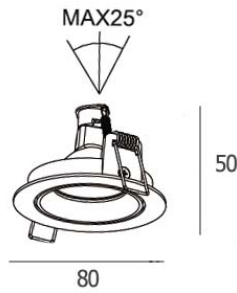

EZY-RB

390.-

DIA 80 mm. H 50 mm.

MR16x1/ GU10/ LED Module
Matt white trim

IP 20

- Adjustable
Matt silver reflector
Accessories : Honeycomb, Frosted glass
Clear glass

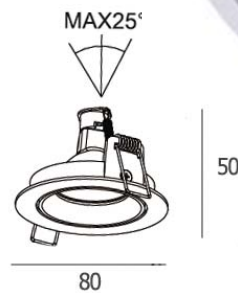

EZY-RC

390.-

DIA 80 mm. H 50 mm.

MR16x1/ GU10/ LED Module
Matt white trim

IP 20

- Adjustable
Shiny reflector
Accessories : Honeycomb, Frosted glass
Clear glass

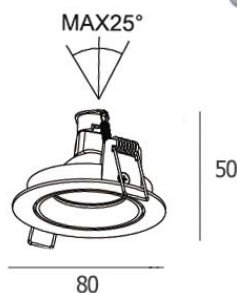

DOWNLIGHT



EZY-RD

390.-

DIA 80 mm. H 50 mm.



MR16x1/ GU10/ LED Module
Matt white trim

IP 20

- Adjustable
- Matt black reflector
- Accessories : Honeycomb, Frosted glass
- Clear glass

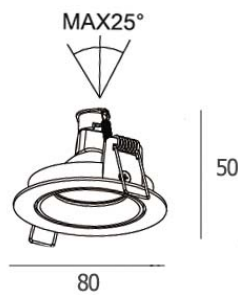

EZY-RE

390.-

DIA 80 mm. H 50 mm.



MR16x1/ GU10/ LED Module
Matt black trim

IP 20

- Adjustable
- Matt black reflector
- Accessories : Honeycomb, Frosted glass
- Clear glass

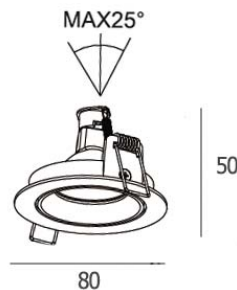





EZY-SA

390.-

DIA 82x82 mm. H 50 mm.

 MR16x1/ GU10/ LED Module
 Matt white trim



IP 20

- Fixed
Matt white reflector
Accessories : Honeycomb, Frosted glass
Clear glass

EZY-SB

390.-

DIA 82x82 mm. H 50 mm.

 MR16x1/ GU10/ LED Module
 Matt white trim

IP 20



- Fixed
Matt silver reflector
Accessories : Honeycomb, Frosted glass
Clear glass



EZY-SC

390.-

DIA 82x82 mm. H 50 mm.

 MR16x1/ GU10/ LED Module
 Matt white trim

IP 20



- Fixed
- Shiny reflector
- Accessories : Honeycomb, Frosted glass
- Clear glass



EZY-SD

390.-

DIA 82x82 mm. H 50 mm.

 MR16x1/ GU10/ LED Module
 Matt white trim

IP 20

- Fixed
- Matt black reflector
- Accessories : Honeycomb, Frosted glass
- Clear glass





JANEN-A

500.-

DIA 85 mm. H 64 mm.



MR16x1/ GU10/ LED Module
Matt white trim

IP 20



Adjustable
Matt white reflector

Accessories : Honeycomb, Frosted glass
Clear glass

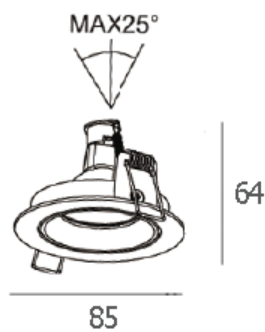

JANEN-B

500.-

DIA 85 mm. H 64 mm.



MR16x1/ GU10/ LED Module
Matt white trim

IP 20



Adjustable
Black mirror reflector

Accessories : Honeycomb, Frosted glass
Clear glass

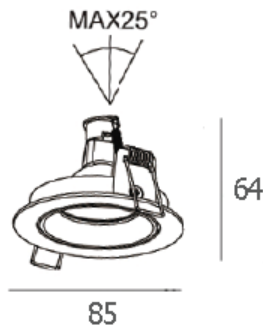



JANEN-C

500.-

DIA 85 mm. H 64 mm.



MR16x1/ GU10/ LED Module
Matt white trim

IP 20



Adjustable
Mirror reflector

Accessories : Honeycomb, Frosted glass
Clear glass

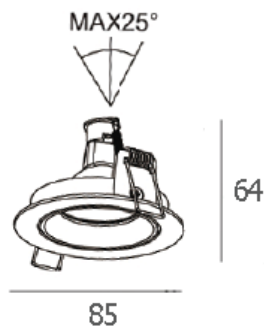

JANEN-D

500.-

DIA 85 mm. H 64 mm.



MR16x1/ GU10/ LED Module
Matt white trim

IP 20



Adjustable
Matt black reflector
Accessories : Honeycomb, Frosted glass
Clear glass

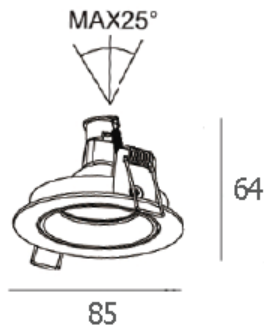

DOWNLIGHT



PELE-R

500.-

DIA 85 mm. H 30 mm.

MR16x1/ GU10/ LED Module
Matt white/ Matt black trim

IP 20

Fully adjustable

PELE-S1

1000.-

DIA 85x85 mm. H 30 mm.

MR16x1/ GU10/ LED Module
Matt white/ Matt black trim

IP 20

Fully adjustable



PELE-S2

1000.-

DIA 85x85 mm. H 30 mm.

MR16x1/ GU10/ LED Module
Matt white/ Matt black trim

IP 20

Fully adjustable



DOWNLIGHT

DOWNLIGHT

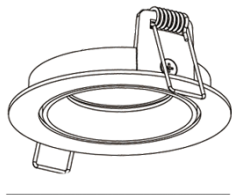

110

ECON-A

350.-

DIA 110 mm. H 50 mm.

MR16x1/ GU10/ LED Module
Matt white trim

IP 20

Fixed
Matt white reflector
Accessories : Honeycomb, Frosted glass
Clear glass

50

ECON-B

350.-

DIA 110 mm. H 50 mm.

MR16x1/ GU10/ LED Module
Matt white trim

IP 20

Fixed
Matt silver reflector
Accessories : Honeycomb, Frosted glass
Clear glass

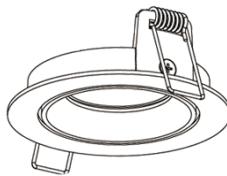

110



50

ECON-C

350.-

DIA 110 mm. H 50 mm.

MR16x1/ GU10/ LED Module
Matt white trim

IP 20

Fixed
Shiny reflector
Accessories : Honeycomb, Frosted glass
Clear glass

50

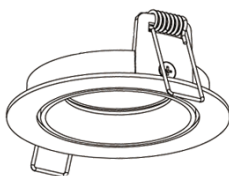

110



NAMI-A

900.-

DIA 84 mm. H 118 mm.

MR16x1
Sand white trim

IP 20

Adjustable
Matt silver reflector

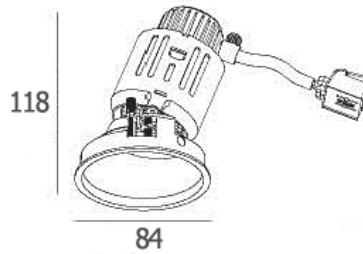

NAMI-B

900.-

DIA 84 mm. H 117 mm.

MR16x1
Sand white trim

IP 20

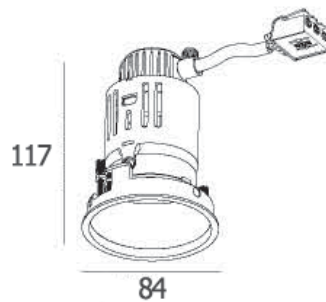

Fixed
Matt silver reflector



SELENA-A

950.-

DIA 115 mm. H 143 mm.

 MR16x1
 Sand white trim

IP 20

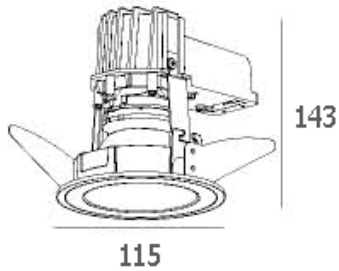

 Adjustable
Shiny reflector



SELENA-B

950.-

DIA 115 mm. H 130 mm.

 MR16x1
 Sand white trim

IP 20

 Fixed
Shiny reflector

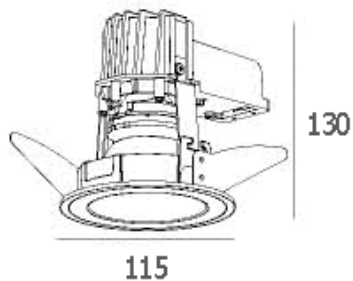





PLAST-R

300.-

DIA 80 mm. H 42 mm.

 MR16x1/ GU10/ LED Module
 Sand white trim



IP 20

-  Fixed
- Accessories : Honeycomb, Frosted glass
Clear glass

PLAST-S1

300.-

DIA 76x76 mm. H 42 mm.

 MR16x1/ GU10/ LED Module
 Sand white trim

IP 20



-  Fixed
- Accessories : Honeycomb, Frosted glass
Clear glass



PLAST-S2

600.-

DIA 76x159 mm. H 42 mm.

 MR16x2/ GU10/ LED Module
 Sand white trim

IP 20

-  Fixed
- Accessories : Honeycomb, Frosted glass
Clear glass

DOWNLIGHT



PINN-A

390.-

DIA 90 mm. H 55 mm.

MR16x1/ GU10/ LED Module
Matt white trim

IP 20

- Adjustable
Accessories : Honeycomb

PINN-B

390.-

DIA 90 mm. H 55 mm.

MR16x1/ GU10/ LED Module
Matt white trim

IP 20

- Fixed
Accessories : Honeycomb



DOWNLIGHT

NOVA-A

600.-

DIA 90 mm. H 73 mm.

MR16x1/ GU10
Sand white trim

IP 20

- Adjustable
- Accessories : Honeycomb, Frosted glass
Clear glass

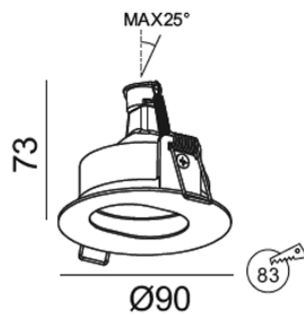

NOVA-B

600.-

DIA 90 mm. H 73 mm.

MR16x1/ GU10
Sand white trim

IP 20

- Fixed
- Accessories : Honeycomb, Frosted glass
Clear glass

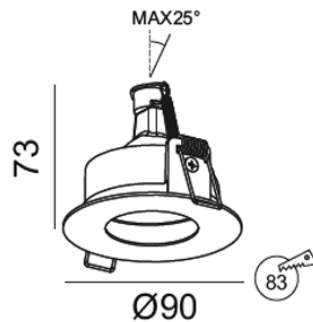

DOWNLIGHT



CETRA-R

350.-

DIA 93 mm. H 41 mm.



MR16x1/ GU10/ LED Module
Matt white/ Matt black trim

IP 20



Adjustable

Accessories : Honeycomb, Frosted glass
Clear glass

CETRA-S

350.-

DIA 90x90 mm. H 41 mm.



MR16x1/ GU10/ LED Module
Matt white/ Matt black trim

IP 20



Adjustable

Accessories : Honeycomb, Frosted glass
Clear glass



DOWNLIGHT



MOBI-R

450.-

DIA 90 mm. H 60 mm.



MR16x1/ GU10/ LED Module
Sand white/ Sand black trim

IP 20

- Adjustable
- Accessories : Honeycomb, Frosted glass
Clear glass

MOBI-S1

450.-

DIA 90x90 mm. H 60 mm.



MR16x1/ GU10/ LED Module
Sand white/ Sand black trim

IP 20

- Adjustable
- Accessories : Honeycomb, Frosted glass
Clear glass



DOWNLIGHT



MOBI-S2

900.-

DIA 90x172 mm. H 60 mm.



MR16x2/ GU10/ LED Module
Sand white/ Sand black trim

IP 20



Adjustable

Accessories : Honeycomb, Frosted glass
Clear glass

ELLIP-R2

900.-

DIA 91.5x172.5 mm. H 53 mm.



MR16x2/ GU10/ LED Module
Sand white/ Sand black trim

IP 20



Adjustable

Accessories : Honeycomb, Frosted glass
Clear glass





AXE-S1

700.-

DIA 125x125 mm. H 150 mm.

 MR16x1
Sand white/ Sand black trim

IP 20

 Adjustable

AXE-S2

1350.-

DIA 125x220 mm. H 150 mm.

 MR16x2
Sand white/ Sand black trim

IP 20

 Adjustable



DOWNLIGHT



CIVIK-1

500.-

DIA 105x105 mm. H 55 mm.



MR16x1/ GU10/ LED Module
Matt white trim

IP 20



Adjustable
Accessories : Honeycomb, Hood

CIVIK-2

750.-

DIA 105x185 mm. H 55 mm.



MR16x1/ GU10/ LED Module
Matt white trim

IP 20



Adjustable
Accessories : Honeycomb, Hood





LUCENT

600.-

DIA 85 mm. H 45 mm.



MR16x1/ GU10/ LED Module
Matt white/ Matt black trim

IP 65



Fixed
Clear glass cover

MIST-R

450.-

DIA 85 mm. H 50 mm.



MR16x1/ GU10/ LED Module
Sand white/ Sand black trim

IP 44



Fixed
Frosted glass cover



DOWNLIGHT



HYDRA-R

600.-

DIA 90 mm. H 100 mm.

 MR16x1
Sand white trim

IP 44

 Fixed
Frosted glass cover

HYDRA-S

600.-

DIA 90x90 mm. H 88 mm.

 MR16x1
Sand white trim

IP 44

 Fixed
Frosted glass cover





DOWNLIGHT



FOGG-WH

500.-

DIA 85 mm. H 45 mm.

 MR16x1/ GU10/ LED Module
 Matt white trim



IP 44

-  Fixed
- Frosted glass cover

FOGG-BK

500.-

DIA 85 mm. H 45 mm.

 MR16x1/ GU10/ LED Module
 Matt black trim

IP 44

-  Fixed
- Frosted glass cover

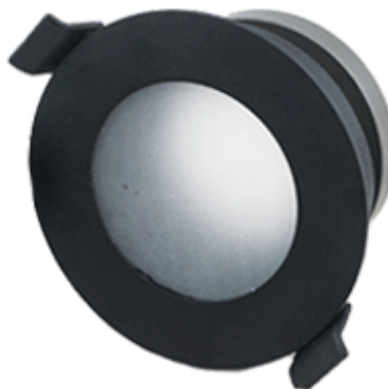

DOWNLIGHT



ATOM-RWW

450.-

DIA 102 mm. H 30 mm.

 MR16x1/ GU10/ LED Module
Matt white trim

IP 20

- Adjustable
Accessories : Honeycomb, Frosted glass
Clear glass

ATOM-SWW

450.-

DIA 102x102 mm. H 30 mm.

 MR16x1/ GU10/ LED Module
Matt white trim

IP 20

- Adjustable
Accessories : Honeycomb, Frosted glass
Clear glass





ATOM-RWB

450.-

DIA 102 mm. H 30 mm.



MR16x1/ GU10/ LED Module
Matt white trim

IP 20



Adjustable
Accessories : Honeycomb, Frosted glass
Clear glass

ATOM-SWB

450.-

DIA 102x102 mm. H 30 mm.



MR16x1/ GU10/ LED Module
Matt white trim

IP 20



Adjustable
Accessories : Honeycomb, Frosted glass
Clear glass



DOWNLIGHT



ROTA-R

350.-

DIA 95 mm. H 35 mm.

MR16x1/ GU10/ LED Module
Matt white/ Matt black trim

IP 20

Adjustable
Accessories : Honeycomb, Hood

ROTA-S1

400.-

DIA 112x112 mm. H 38 mm.

MR16x1/ GU10/ LED Module
Matt white/ Matt black trim

IP 20

Adjustable
Accessories : Honeycomb, Hood



ROTA-S2

700.-

DIA 112x210 mm. H 38 mm.

MR16x1/ GU10/ LED Module
Matt white/ Matt black trim

IP 20

Adjustable
Accessories : Honeycomb, Hood

TRIM-S1 MR16

800.-

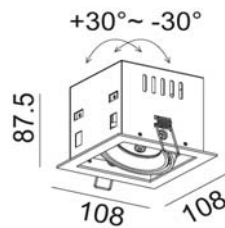

DIA 108x108 mm. H 87.5 mm.



MR16x1/ LED Module
Sand white/ Sand black trim
Sand black ring



Fully adjustable
Accessories : Honeycomb, Frosted glass
Clear glass.

TRIM-S2 MR16

1450.-

DIA 108x200 mm. H 87.5 mm.



MR16x2/ LED Module
Sand white/ Sand black trim
Sand black ring



Fully adjustable
Accessories : Honeycomb, Frosted glass
Clear glass.

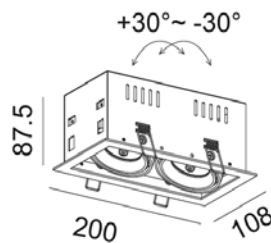

TRIM-S3 MR16

1950.-

DIA 108x288 mm. H 87.5 mm.



MR16x3/ LED Module
Sand white/ Sand black trim
Sand black ring



Fully adjustable
Accessories : Honeycomb, Frosted glass
Clear glass.

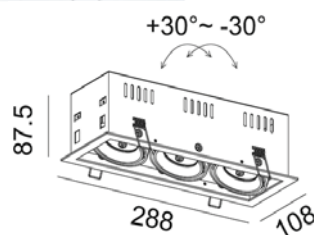



TRIMLESS-S1

950.-

DIA 95x95 mm. H 85 mm.

MR16x1/ LED Module
Sand white/ Sand black

IP 20

Trimless style
Fully adjustable
Accessories : Honeycomb, Frosted glass
Clear glass

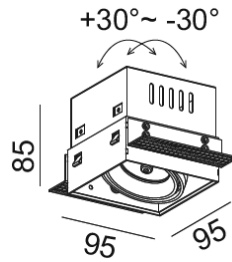

TRIMLESS-S2

1650.-

DIA 95x185 mm. H 85 mm.

MR16x2/ LED Module
Sand white/ Sand black

IP 20

Trimless style
Fully adjustable
Accessories : Honeycomb
Clear glass

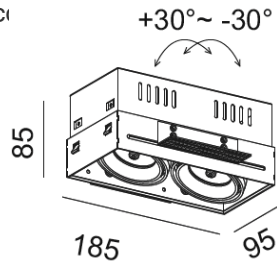

TRIMLESS-S3

2250.-

DIA 95x275 mm. H 85 mm.

MR16x3/ LED Module
Sand white/ Sand black trim

IP 20

Trimless style
Fully adjustable
Accessories : Honeycomb, Frosted glass
Clear glass

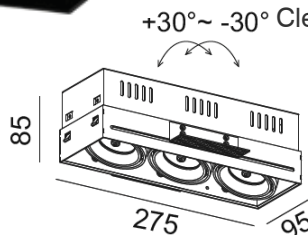

DOWNLIGHT



DEPT-R

600.-

DIA 90 mm. H 85 mm.



MR16x1/ GU10/ LED Module
Sand white trim

IP 20



Fully adjustable

Accessories : Honeycomb, Frosted glass
Clear glass

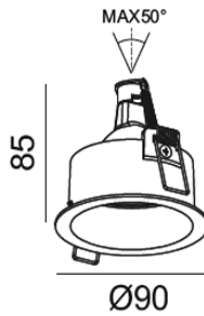

DEPT-S

600.-

DIA 90x90 mm. H 85 mm.



MR16x1/ GU10/ LED Module
Sand white trim

IP 20



Fully adjustable

Accessories : Honeycomb, Frosted glass
Clear glass

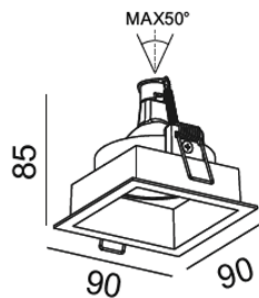



DOWNLIGHT



TOMI-A

600.-

DIA 88 mm. H 110 mm.

 MR16x1
 Sand white trim

IP 20

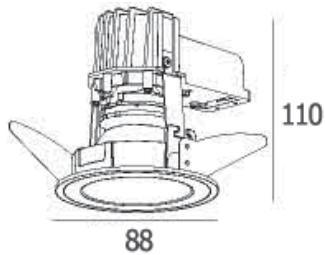

 Adjustable
Matt white reflector



TOMI-B

600.-

DIA 88 mm. H 110 mm.

 MR16x1
 Sand white trim

IP 20

 Adjustable
Matt silver reflector

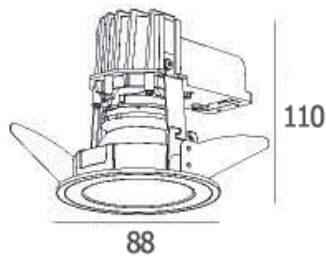

DOWNLIGHT



TOMI-C

600.-

DIA 88 mm. H 110 mm.

MR16x1
Sand white trim

IP 44

Adjustable
Frosted glass cover

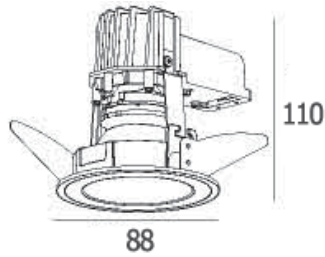

TOMI-D

600.-

DIA 88 mm. H 110 mm.

MR16x1
Sand white trim

IP 20

Adjustable
Matt black reflector

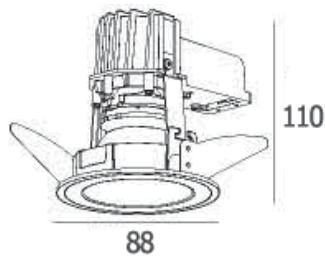

DOWNLIGHT



WINK-A

600.-

DIA 107 mm. H 103 mm.

MR16x1
Matt white trim

IP 20

Adjustable
Shiny reflector

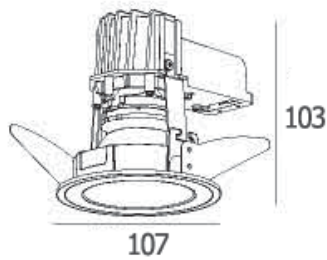

WINK-B

600.-

DIA 107 mm. H 103 mm.

MR16x1
Matt white trim

IP 20

Fixed
Shiny reflector

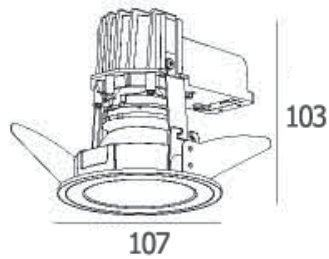

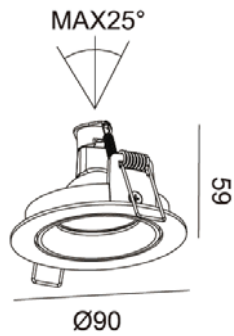
**DENN****500.-**

DIA 90 mm. H 59 mm.

 MR16x1/ GU10/ LED Module
 Sand white/ Sand black trim

IP 20

- Adjustable
- Accessories : Honeycomb, Frosted glass
Clear glass

PULLER**1000.-**

DIA 100 mm. H 100 mm.

 GU10x1
 Sand white/ Sand black

IP 20

- Fully adjustable

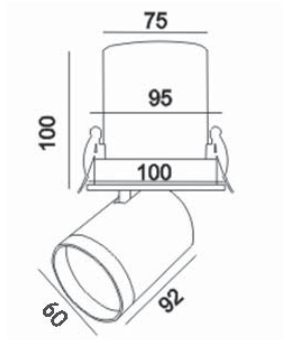



NURA-A

1200.-

DIA 104×194 mm. H 72 mm.



MR16x1/ GU10/ LED Module
Matt white trim

IP 20



Adjustable
Matt white reflector

Accessories : Honeycomb, Frosted glass
Clear glass

NURA-B

1200.-

DIA 104×194 mm. H 72 mm.



MR16x1/ GU10/ LED Module
Matt white trim

IP 20



Adjustable
Matt black reflector
Accessories : Honeycomb, Frosted glass
Clear glass





NURA-C

1200.-

DIA 104×194 mm. H 72 mm.



MR16x1/ GU10/ LED Module
Matt white trim

IP 20



Adjustable
Mirror reflector
Accessories : Honeycomb, Frosted glass
Clear glass

NURA-D

1200.-

DIA 104×194 mm. H 72 mm.



MR16x1/ GU10/ LED Module
Matt white trim

IP 20



Adjustable
Accessories : Honeycomb, Frosted glass
Clear glass







MANA-S1A

500.-

DIA 89×89 mm. H 72 mm.

 MR16x1/ GU10/ LED Module
 Matt white trim



IP 20

-  Adjustable
Matt white reflector
Accessories : Honeycomb, Frosted glass
Clear glass

MANA-S1B

500.-

DIA 89×89 mm. H 72mm.

 MR16x1/ GU10/ LED Module
 Matt white trim

IP 20



-  Adjustable
Matt black reflector
Accessories : Honeycomb, Frosted glass
Clear glass



MANA-S1C

500.-

DIA 89×89 mm. H 72 mm.

 MR16x1/ GU10/ LED Module
 Matt white trim

IP 20

-  Adjustable
Mirror reflector
Accessories : Honeycomb, Frosted glass
Clear glass



DOWNLIGHT

DOWNLIGHT



MANA-S2A

1000.-

DIA 89×164 mm. H 72 mm.

MR16x1/ GU10/ LED Module
Matt white trim

IP 20

- Adjustable
Matt white reflector
Accessories : Honeycomb, Frosted glass
Clear glass

MANA-S2B

1000.-

DIA 89×164 mm. H 72 mm.

MR16x1/ GU10/ LED Module
Matt white trim

IP 20

- Adjustable
Matt black reflector
Accessories : Honeycomb, Frosted glass
Clear glass



MANA-S2C

1000.-

DIA 89×164 mm. H 72 mm.

MR16x1/ GU10/ LED Module
Matt white trim

IP 20

- Adjustable
Mirror reflector
Accessories : Honeycomb, Frosted glass
Clear glass



DOWNLIGHT

DOWNLIGHT



SNOW-R

750.-

DIA 180 mm. H 28 mm.

AR111x1
Sand white trim

IP 20

Adjustable

SNOW-S1

750.-

DIA 180x180 mm. H 28 mm.

AR111x1
Sand white trim

IP 20

Adjustable



SNOW-S2

1500.-

DIA 180x356 mm. H 28 mm.

AR111x2
Sand white trim

IP 20

Adjustable



DOWNLIGHT



SNOOT-PR1

1000.-

DIA 180x180 mm. H 200 mm.

 PAR30S/ PAR30Lx1
 Sand white trim



IP 20

 Adjustable

SNOOT-PR2

2000.-

DIA 180x347 mm. H 200 mm.

 PAR30S/ PAR30Lx2
 Sand white trim

IP 20

 Adjustable



DOWNLIGHT



TRIM-XR

950.-

DIA 170 mm. H 70 mm.

MR16x1/ GU10
Sand white trim

IP 20

Adjustable

TRIM-L1

1000.-

DIA 173x173 mm. H 115 mm.

AR111x1
Matt white trim

IP 20

Fully adjustable



TRIM-L2

1850.-

DIA 173x320 mm. H 115 mm.

AR111x2
Matt white trim

IP 20

Fully adjustable



DOWNLIGHT



SAKURA-R

1000.-

DIA 170 mm. H 53 mm.

AR111x1
Sand white trim

IP 20

Fully adjustable

SAKURA-S1

1000.-

DIA 170x170 mm. H 53 mm.

AR111x1
Sand white trim

IP 20

Fully adjustable



SAKURA-S2

2000.-

DIA 170x325 mm. H 50 mm.

AR111x2
Sand white trim

IP 20

Fully adjustable

DOWNLIGHT



VICTOR

600.-

DIA 153 mm. H 57 mm.

 AR111x1
Matt white trim

IP 20

 Fixed

FOCAL

500.-

DIA 68 mm. H 55 mm.

 MR16x1/ GU10/ LED Module
Sand white/ Sand black trim

IP 20

 Fixed



DOWNLIGHT



SNOOT-R

600.-

DIA 175 mm. H 120-150 mm.

PAR30S/ PAR30Lx1
Matt white trim

IP 20

Fully adjustable

LUXX-PAR30

650.-

DIA 135 mm. H 140-180 mm.

PAR30S/ PAR30Lx1
Sand white/ Sand black trim

IP 20

Fixed



HEX-PAR30

650.-

DIA 125x125 mm. H 140-180 mm.

PAR30S/ PAR30Lx1
Sand white/ Sand black trim

IP 20



Fixed

DOWNLIGHT



HEX-S2-WH PAR30 1300.-

DIA 125×225 mm. H 140-180 mm.

 PAR30S/ PAR30Lx1
 Sand white

IP 20

 Fixed

HEX-S2-BK PAR30 1300.-

DIA 125×225 mm. H 140-180 mm.

 PAR30S/ PAR30Lx1
 Sand black trim

IP 20

 Fixed



DOWNLIGHT

A 4x4 grid of squares with a blue-to-white gradient. The top row is the lightest blue, and the bottom row is the darkest blue. The text 'LED DOWNLIGHT' is written in white, bold, italicized capital letters at the bottom of the grid.

LED DOWNLIGHT



TESLA-RM 18W

1000.-

DIA 150 mm. H 50 mm.



LED SMD 18W 1710lm

120° 3000K, 4000K
Matt white trim

IP 20

- Aluminium Body
- Driver included
- Non-Dim
- Dimmable (0-10V/ Triac) Optional

TESLA-SM 18W

1000.-

DIA 145x145 mm. H 50 mm.



LED SMD 18W 1710lm

120° 3000K, 4000K
Matt white trim

IP 20

- Aluminium Body
- Driver included
- Non-Dim
- Dimmable (0-10V/ Triac) Optional





TESLA-RL 24W

1200.-

DIA 170 mm. H 50 mm.



LED SMD 24W 2400lm

120° 3000K, 4000K
Matt white trim

IP 20

- Aluminium Body
- Driver included
- Non-Dim
- Dimmable (0-10V/ Triac) Optional

TESLA-SL 24W

1200.-

DIA 165x165 mm. H 50 mm.



LED SMD 24W 2400lm

120° 3000K, 4000K
Matt white trim

IP 20

- Aluminium Body
- Driver included
- Non-Dim
- Dimmable (0-10V/ Triac) Optional





POTTER-S 9W

800.-

DIA 115 mm. H 80 mm.



LED SMD 9W 582lm



3000K, 4000K
Matt white trim

IP 20

- Aluminium Body
- LED Driver included
- Non-Dim
- Dimmable (0-10V/ Triac) Optional

POTTER-M 15W

1200.-

DIA 140 mm. H 85 mm.



LED SMD 15W 955lm



3000K, 4000K
Matt white trim

IP 20

- Aluminium Body
- LED Driver included
- Non-Dim
- Dimmable (0-10V/ Triac) Optional



POTTER-L 21W

1500.-

DIA 165 mm. H 100 mm.



LED SMD 21W 1440lm



3000K, 4000K
Matt white trim

IP 20

- Aluminium Body
- LED Driver included
- Non-Dim
- Dimmable (0-10V/ Triac) Optional

LED DOWNLIGHT



MATT-M 15W

2000.-

DIA 159x159 mm. H 65 mm.



LED SMD 15W 1170lm

120° 3000K,
Matt white trim

IP 20

- Aluminium Body
- Driver included
- Non-Dim
- Dimmable (0-10V/ Triac) Optional

MATT-L 25W

3350.-

DIA 195x195 mm. H 75 mm.



LED SMD 25W 1950lm

120° 3000K, 4000K
Matt white trim

IP 20

- Aluminium Body
- Driver included
- Non-Dim
- Dimmable (0-10V/ Triac) Optional





EMIT-RM 15W

1500.-

DIA 115 mm. H 120 mm.



CREE CHIP LED 15W 1310lm



3000K, 4000K
Matt white trim

IP 20

- Adjustable
- Aluminium Body
- Driver included
- Non-Dim
- Dimmable (0-10V/ Triac) Optional

EMIT-S1 15W

1500.-

DIA 115x115 mm. H 120 mm.



CREE CHIP LED 15W 1310lm



3000K, 4000K
Matt white trim

IP 20

- Adjustable
- Aluminium Body
- Driver included
- Non-Dim
- Dimmable (0-10V/ Triac) Optional



EMIT-S2 2x15W

3000.-

DIA 115x210 mm. H 120 mm.



CREE CHIP LED 2x15W 2610lm



3000K, 4000K
Matt white trim

IP 20

- Adjustable
- Aluminium Body
- Driver included
- Non-Dim
- Dimmable (0-10V/ Triac) Optional



LED DOWNLIGHT

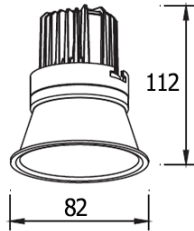

LUCAS-RS 7W

1200.-

DIA 82 mm. H 92 mm.



CREE CHIP LED 7W 577lm



3000K, 4000K
Matt white trim

IP 20



Fixed
Aluminium Body
Driver included
Non-Dim
Dimmable (0-10V/ Triac) Optional

LUCAS-RM 12W

1650.-

DIA 108 mm. H 130 mm.



CREE CHIP LED 12W 920lm



3000K, 4000K
Matt white trim

IP 20



Fixed
Aluminium Body
Driver included
Non-Dim
Dimmable (0-10V/ Triac) Optional

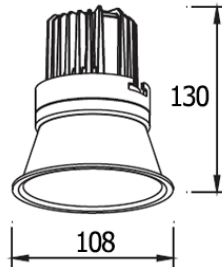

LUCAS-RL 18W

2500.-

DIA 133 mm. H 160 mm.



CREE CHIP LED 18W 1393lm



3000K, 4000K
Matt white trim

IP 20



Fixed
Aluminium Body
Driver included
Non-Dim
Dimmable (0-10V/ Triac) Optional





LUCAS-SS 7W

1200.-

DIA 90x90 mm. H 94.5 mm.



CREE CHIP LED 7W 577lm



3000K, 4000K
Matt white trim

IP 20

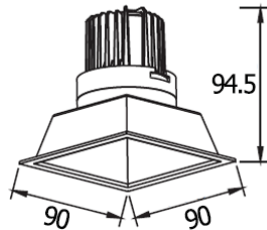

- Fixed
- Aluminium Body
- Driver included
- Non-Dim
- Dimmable (0-10V/ Triac) Optional

LUCAS-SM 12W

1650.-

DIA 115x115 mm. H 115 mm.



CREE CHIP LED 12W 920lm



3000K, 4000K
Matt white trim

IP 20



- Fixed
- Aluminium Body
- Driver included
- Non-Dim
- Dimmable (0-10V/ Triac) Optional

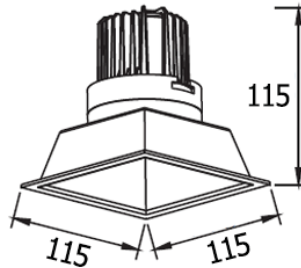

LUCAS-SL 18W

2500.-

DIA 140x140 mm. H 152 mm.



CREE CHIP LED 18W 1430lm



3000K, 4000K
Matt white trim

IP 20

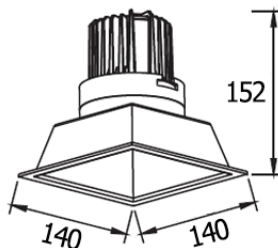

- Fixed
- Aluminium Body
- Driver included
- Non-Dim
- Dimmable (0-10V/ Triac) Optional

MARA-RM 12W

2000.-

DIA 115 mm. H 115 mm.



CREE CHIP LED 12W 920lm



3000K, 4000K
Matt white trim

IP 20

- Adjustable
- Aluminium Body
- Driver included
- Non-Dim
- Dimmable (0-10V/ Triac) Optional

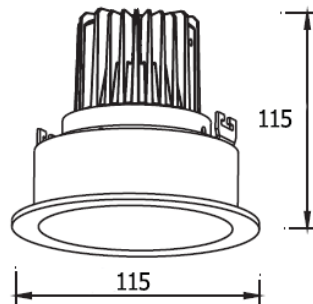

MARA-RL 18W

3000.-

DIA 153 mm. H 150 mm.



CREE CHIP LED 18W 1403lm



3000K, 4000K
Matt white trim

IP 20

- Adjustable
- Aluminium Body
- Driver included
- Non-Dim
- Dimmable (0-10V/ Triac) Optional

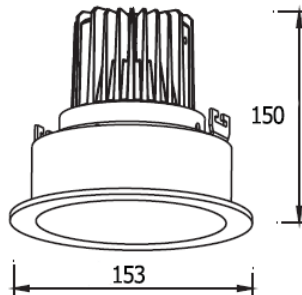



MARA-SM 12W

2000.-

DIA 114x114 mm. H 114 mm.



CREE CHIP LED 12W 920lm



3000K, 4000K
Matt white trim

IP 20

- Adjustable
- Aluminium Body
- Driver included
- Non-Dim
- Dimmable (0-10V/ Triac) Optional

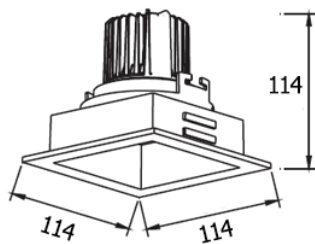

MARA-SL 18W

3000.-

DIA 154.5x154.5 mm. H 150 mm.



CREE CHIP LED 18W 1403lm



3000K, 4000K
Matt white trim

IP 20

- Adjustable
- Aluminium Body
- Driver included
- Non-Dim
- Dimmable (0-10V/ Triac) Optional

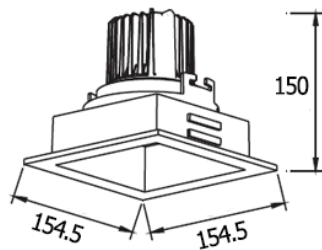



AURA-S 8W

1200.-

DIA 72 mm. H 76 mm.



LED COB 8W 685lm

15° 24° 38°

3000K, 4000K
Matt white trim

IP 20

- Adjustable
- Aluminium Body
- Dark mirror reflector
- Driver included
- Non-Dim
- Dimmable (0-10V/ Triac) Optional

AURA-M 15W

1650.-

DIA 88 mm. H 88 mm.



LED COB 15W 1312lm

15° 24° 38°

3000K, 4000K
Matt white trim

IP 20

- Adjustable
- Aluminium Body
- Dark mirror reflector
- Driver included
- Non-Dim
- Dimmable (0-10V/ Triac) Optional





BETAGA-M

1350.-

DIA 45x147 mm. H 49 mm.



LED COB 5x2W 890lm

3000K, 4000K
Matt white trim



Fixed
Recessed type
Aluminium Body
Driver included
Non-Dim
Dimmable (0-10V/ Triac) Optional

BETAGA-L

2500.-

DIA 45x280 mm. H 49 mm.



LED COB 10x2W 1780lm

3000K, 4000K
Matt white trim



Fixed
Recessed type
Aluminium Body
Driver included
Non-Dim
Dimmable (0-10V/ Triac) Optional



BETAGA-XL

3600.-

DIA 45x415 mm. H 49 mm.



LED COB 15x2W 2670lm

3000K, 4000K
Matt white trim



Fixed
Recessed type
Aluminium Body
Driver included
Non-Dim
Dimmable (0-10V/ Triac) Optional



LED DOWNLIGHT



TRIM-S1 LED 10W

1800.-

DIA 108x108 mm. H 87.5 mm.



CREE CHIP LED 10W 830lm



3000K, 4000K, 6000K
Sand white trim



Adjustable
Aluminium Body
Driver included
Non-Dim
Dimmable (0-10V/ Triac) Optional

IP 20

TRIM-S2 LED 2x10W

3500.-

DIA 108x200 mm. H 87.5 mm.



CREE CHIP LED 2x10W 1660lm



3000K, 4000K, 6000K
Sand white trim



Adjustable
Aluminium Body
Driver included
Non-Dim
Dimmable (0-10V/ Triac) Optional

IP 20



LED DOWNLIGHT



TRIM-M1 LED 18W

3000.-

DIA 135x135 mm. H 110 mm.



CREE CHIP LED 18W 1312lm



3000K, 4000K
Sand white trim

IP 20

- Adjustable
- Aluminium Body
- Driver included
- Non-Dim
- Dimmable (0-10V/ Triac) Optional

TRIM-M2 LED 2x18W

5000.-

DIA 135x267 mm. H 110 mm.



CREE CHIP LED 2x18W 2691lm



3000K, 4000K
Sand white trim

IP 20

- Adjustable
- Aluminium Body
- Driver included
- Non-Dim
- Dimmable (0-10V/ Triac) Optional



LED DOWNLIGHT



LUZE-M 15W

2000.-

DIA 110 mm. H 100 mm.



PHILIPS CHIP LED 15W 1219lm



3000K, 4000K
Matt white trim



Fixed

Aluminium Body

Driver included

Non-Dim

Dimmable (0-10V/ Triac) Optional

IP 20

LUZE-L 20W

2500.-

DIA 140 mm. H 147 mm.



PHILIPS CHIP LED 20W 1626lm



3000K, 4000K
Matt white trim



Fixed

Aluminium Body

Driver included

Non-Dim

Dimmable (0-10V/ Triac) Optional

IP 20





NEWTON-S 9W

950.-

DIA 85 mm. H 53 mm.



LED COB 9W 810lm

3000K, 4000K
Matt white trim

IP 20

- Fully adjustable
- Aluminium Body
- Driver included
- Non-Dim
- Dimmable (0-10V/ Triac) Optional

NEWTON-M 18W

1750.-

DIA 110 mm. H 75 mm.



LED COB 18W 1600lm

3000K, 4000K, 6500K
Matt white trim

IP 20

- Fully adjustable
- Aluminium Body
- Driver included
- Non-Dim
- Dimmable (0-10V/ Triac) Optional



NEWTON-L 30W

3150.-

DIA 150 mm. H 100 mm.



LED COB 30W 2700lm

3000K, 4000K, 6500K
Matt white trim

IP 20

- Fully adjustable
- Aluminium Body
- Driver included
- Non-Dim
- Dimmable (0-10V/ Triac) Optional

LED DOWNLIGHT



WALLY-S 12W

1500.-

DIA 108 mm. H 100 mm.



LED COB 12W 1026lm

3000K, 4000K

Matt white trim

IP 20



Fixed

Wall washer downlight

Aluminium Body

Driver included

Non-Dim

Dimmable (0-10V/ Triac) Optional

WALLY-M 20W

2000.-

DIA 108 mm. H 100 mm.



LED COB 20W 1710lm

3000K, 4000K

Matt white trim

IP 20



Fixed

Wall washer downlight

Aluminium Body

Driver included

Non-Dim

Dimmable (0-10V/ Triac) Optional





PITT-S 12W

1500.-

DIA 85 mm. H 73 mm.



LED COB 12W 1026lm

3000K, 4000K

Matt white trim

IP 20



Fixed

Wall washer downlight

Aluminium Body

Driver included

Non-Dim

Dimmable (0-10V/ Triac) Optional

PITT-M 20W

2000.-

DIA 105 mm. H 97 mm.



LED COB 20W 1710lm

3000K, 4000K

Matt white trim

IP 20



Fixed

Wall washer downlight

Aluminium Body

Driver included

Non-Dim

Dimmable (0-10V/ Triac) Optional

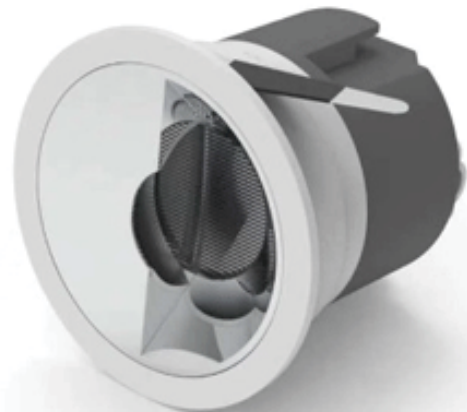



HEXTA-S 10W

1000.-

DIA 93 mm. H 65 mm.



LED COB 10W 855lm
3000K, 4000K
Matt white trim

IP 20

- 15D-60D Baem angle adjustable
Fully adjustable
Aluminium Body
Driver included
Non-Dim
Dimmable (0-10V/ Triac) Optional

HEXTA-M 20W

1500.-

DIA 115 mm. H 95 mm.



LED COB 20W 1710lm
3000K, 4000K
Matt white trim

IP 20

- 15D-60D Baem angle adjustable
Fully adjustable
Aluminium Body
Driver included
Non-Dim
Dimmable (0-10V/ Triac) Optional



HEXTA-L 30W

2000.-

DIA 130 mm. H 120 mm.



LED COB 30W 2400lm
3000K, 4000K
Matt white trim

IP 20

- 15D-60D Baem angle adjustable
Fully adjustable
Aluminium Body
Driver included
Non-Dim
Dimmable (0-10V/ Triac) Optional



LED DOWNLIGHT



NEPTA-S 10W

1000.-

DIA 92 mm. H 75 mm.



LED COB 10W 855lm
3000K, 4000K
Matt white trim

IP 20

- Fully adjustable
- Aluminium Body
- Driver included
- Non-Dim
- Dimmable (0-10V/ Triac) Optional

NEPTA-M 20W

1500.-

DIA 135 mm. H 115 mm.



LED COB 20W 1710lm
3000K, 4000K
Matt white trim

IP 20

- Fully adjustable
- Aluminium Body
- Driver included
- Non-Dim
- Dimmable (0-10V/ Triac) Optional



NEPTA-L 30W

2000.-

DIA 135 mm. H 115 mm.



LED COB 30W 2400lm
3000K, 4000K
Matt white trim

IP 20

- Fully adjustable
- Aluminium Body
- Driver included
- Non-Dim
- Dimmable (0-10V/ Triac) Optional





JOOX-A 3W

750.-

DIA 50 mm. H 30 mm.



CREE CHIP LED 3W 265lm



3000K, 4000K
Matt white trim

IP 20

- Adjustable
- Aluminium Body
- Driver included
- Non-Dim
- Dimmable (0-10V/ Triac) Optional

JOOX-B 3W

750.-

DIA 40 mm. H 28 mm.



CREE CHIP LED 3W 265lm



3000K, 4000K
Matt white trim

IP 20

- Fixed
- Aluminium Body
- Driver included
- Non-Dim
- Dimmable (0-10V/ Triac) Optional





CONIX 5W

750.-

DIA 50 mm. H 50 mm.



CREE CHIP LED 5W 405lm



3000K, 4000K

Matt white/ Matt black trim

IP 20



Adjustable

Aluminium Body

Driver included

Non-Dim

Dimmable (0-10V/ Triac) Optional

BETA 6W

1000.-

DIA 58 mm. H 60 mm.



CREE CHIP LED 6W 495lm



3000K, 4000K

Matt white trim

IP 20



Fixed

Aluminium Body

Driver included

Non-Dim

Dimmable (0-10V/ Triac) Optional





NANO-R 10W

2150.-

DIA 90 mm. H 77 mm.



CREE CHIP LED 10W 843lm



3000K, 4000K
Matt white trim

IP 65

- Adjustable
- Aluminium Body
- Driver included
- Non-Dim
- Dimmable (0-10V/ Triac) Optional

NANO-S 10W

2150.-

DIA 90x90 mm. H 77 mm.



CREE CHIP LED 10W 843lm



3000K, 4000K
Matt white trim

IP 65

- Adjustable
- Aluminium Body
- Driver included
- Non-Dim
- Dimmable (0-10V/ Triac) Optional



TITAN 10W

2150.-

DIA 90 mm. H 92 mm.



LED COB 10W 755lm



3000K, 4000K
Matt white/ Matt black trim

IP 65

- Fixed
- Aluminium Body
- Driver included
- Non-Dim
- Dimmable (0-10V/ Triac) Optional

LED DOWNLIGHT



MINI 3W

750.-

DIA 52 mm. H 25 mm.



CREE CHIP LED 3W 260lm



3000K, 4000K, 6000K

Matt white/ Matt black/ Silver



Adjustable
Aluminium Body

Driver included

Non-Dim

Dimmable (0-10V/ Triac) Optional

IP 20

MINI-D 3W

1000.-

DIA 52 mm. H 35 mm.



LED COB 3W 260lm



3000K, 4000K

Sand white/ Sand black trim



Adjustable
Aluminium Body

Driver included

Non-Dim

Dimmable (0-10V/ Triac) Optional

IP 20

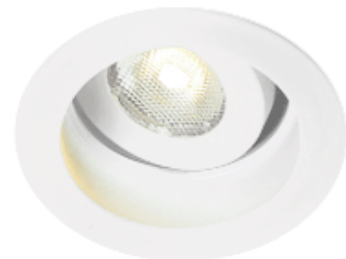



DOSS 1.5W

600.-

DIA 35 mm. H 22 mm.



LED COB 1.5W 140lm



3000K, 4000K

Matt white, Matt black trim



Fixed

Aluminium Body

Driver included

Non-Dim

Dimmable (0-10V/ Triac) Optional

IP 20

RIZ 3W

750.-

DIA 40 mm. H 50 mm.



CREE CHIP LED 3W 260lm



3000K, 4000K

Matt white, Matt black trim



Fixed

Aluminium Body

Driver included

Non-Dim

Dimmable (0-10V/ Triac) Optional

IP 20



FOCUS 3W

850.-

DIA 48 mm. H 37 mm.



CREE CHIP LED 3W 260lm



3000K, 6000K

Matt white, Matt black trim



Fully adjustable

Aluminium Body

Driver included

Non-Dim

Dimmable (0-10V/ Triac) Optional

IP 20

LED DOWNLIGHT



BELETTA-M

2500.-

DIA 42x278 mm. H 50 mm.



LED SMD 10W 890lm



3000K, 4000K
Matt white trim

IP 20



Fixed

Recessed type
Aluminium Body
Driver included
Non-Dim
Dimmable (0-10V/ Triac) Optional

BELETTA-L

3500.-

DIA 42x545 mm. H 50 mm.



LED SMD 20W 1780lm



3000K, 4000K
Matt white trim

IP 20



Fixed

Recessed type
Aluminium Body
Driver included
Non-Dim
Dimmable (0-10V/ Triac) Optional



LED DOWNLIGHT



BEBETO-M

2500.-

DIA 50x273 mm. H 42 mm.



LED SMD 10W 890lm

3000K, 4000K
Matt black

IP 20



Fixed

Recessed type

Trimless design

Aluminium Body

Driver included

Non-Dim

Dimmable (0-10V/ Triac) Optional

BEBETO-L

3500.-

DIA 50x540 mm. H 42 mm.



LED SMD 20W 1780lm

3000K, 4000K
Matt black

IP 20



Fixed

Trimless design

Aluminium Body

Driver included

Non-Dim

Dimmable (0-10V/ Triac) Optional



LED DOWNLIGHT



BELINA-M

2500.-

DIA 50x273 mm. H 42 mm.



LED COB 10W 890lm



3000K, 4000K
Matt black

IP 20



Fixed

Recessed type

Trimless design

Aluminium Body

Driver included

Non-Dim

Dimmable (0-10V/ Triac) Optional

BELINA-L

3500.-

DIA 50x540 mm. H 42 mm.



LED COB 20W 1780lm



3000K, 4000K
Matt black

IP 20



Fixed

Recessed type

Trimless design

Aluminium Body

Driver included

Non-Dim

Dimmable (0-10V/ Triac) Optional



LED DOWNLIGHT

NORI

1500.-

DIA 85 mm. H 70 mm.



LED COB 10W 890lm

3000K, 4000K

Matt white/ matt black

IP 20



Adjustable

Accessories : Sling Hanging Wire Kit

Aluminium Body

Driver included

Non-Dim



REEL

2400.-

DIA 115 mm. H 135 mm.



LED COB 20W 1890lm

3000K, 4000K

Matt white/ matt black

IP 20



Fixed

Accessories : Sling Hanging Wire Kit

Aluminium Body

Driver included

Non-Dim



JAZZ

800.-

DIA 70 mm. H 55 mm.



LED COB 7W 550lm

3000K, 4000K

Matt white/ matt black

IP 20



Fixed

Accessories : Sling Hanging Wire Kit

Aluminium Body

Driver included

Non-Dim



MOON

1000.-

DIA 140 mm. H 75 mm.



LED SMD 15W 1312lm

3000K, 4000K

Matt white/ matt black

IP 20



Fixed

Accessories : Sling Hanging Wire Kit

Aluminium Body

Driver included

Non-Dim



LED DOWNLIGHT

BETINI-M

1500.-

DIA 33x60 mm. L 270 mm.



LED COB 10x1W 890lm

3000K, 4000K
Matt white/ matt black

IP 20



Fixed
Aluminium Body
Driver included
Non-Dim



BETINI-L

2500.-

DIA 33x60 mm. L 535 mm.



LED COB 20x1W 1780lm

3000K, 4000K
Matt white/ matt black

IP 20



Fixed
Aluminium Body
Driver included
Non-Dim



LED DOWNLIGHT



ADEN-S

2000.-

DIA 37x135 mm. H 60 mm.



LED COB 5x2W 800lm

3000K, 4000K
Matt black

IP 20

- Surface mounted type
Adjustable 1 side
Aluminium Body
Driver included
Non-Dim

ADEN-M

3000.-

DIA 37x270 mm. H 60 mm.



LED COB 10x2W 1600lm

3000K, 4000K
Matt black

IP 20

- Surface mounted type
Adjustable 1 side
Aluminium Body
Driver included
Non-Dim



ADEN-L

4000.-

DIA 37x405 mm. H 60 mm.



LED COB 15x2W 2400lm

3000K, 4000K
Matt black

IP 20

- Surface mounted type
Adjustable 1 side
Aluminium Body
Driver included
Non-Dim



LED DOWNLIGHT

BENITO-M

1500.-

DIA 33x60 mm. L 270 mm.



LED SMD 10W 890lm

3000K, 4000K

Matt white/ matt black

IP 20



Fixed

Aluminium Body

Driver included

Non-Dim

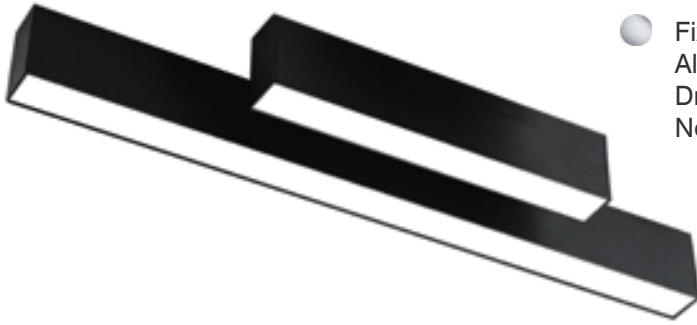

BENITO-L

2500.-

DIA 33x60 mm. L 535 mm.



LED SMD 20W 1780lm

3000K, 4000K

Matt white/ matt black

IP 20



Fixed

Aluminium Body

Driver included

Non-Dim

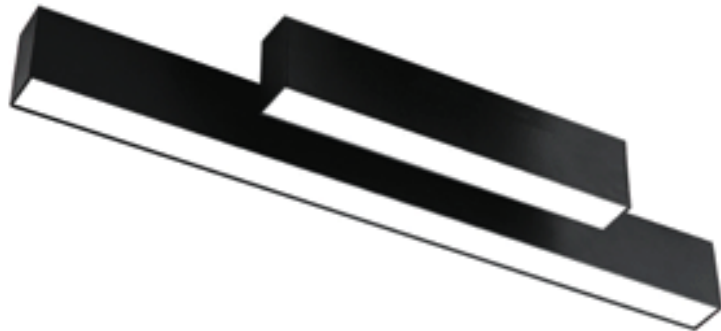

LED DOWNLIGHT

A 5x4 grid of squares. The top row is white, the second row is light blue, the third row is medium blue, the fourth row is dark blue, and the bottom row is the darkest blue. The text 'DOWNLIGHT E27' is written in white, bold, italicized font in the bottom right corner of the grid.

DOWNLIGHT E27



SNOOT-E1

700.-

DIA 130x130 mm. H 150 mm.



E27x1
Sand white trim/ Black ring

IP 20



Adjustable
Matt silver reflector

SNOOT-E2

1300.-

DIA 130x250 mm. H 150 mm.



E27x2
Sand white trim/ Black ring

IP 20



Adjustable
Matt silver reflector



DOWNLIGHT

SNOOT-S1

800.-

DIA 145x145 mm. H 150 mm.



E27x1



Sand white trim/ Black ring

IP 20



Fully adjustable

Matt silver reflector



SNOOT-S2

1500.-

DIA 145x275 mm. H 150m mm.



E27x2



Sand white trim/ Black ring

IP 20



Fully adjustable

Matt silver reflector



DOWNLIGHT



SNOOT-L1

1000.-

DIA 170x170 mm. H 200 mm.



E27x1



Sand white trim/ Black ring

IP 20



Fully adjustable

Matt silver reflector

SNOOT-L2

1950.-

DIA 170x325 mm. H 200mm.



E27x2



Sand white trim/ Black ring

IP 20



Fully adjustable

Matt silver reflector



DOWNLIGHT



HEX-SWW

550.-

DIA 125x125 mm. H 170 mm.

 E27x1
 Sand white trim/ White inside

IP 20

 Fixed
Matt silver reflector

HEX-SWB

600.-

DIA 125x125 mm. H 170 mm.

 E27x1
 Sand white trim/ Black inside

IP 20



 Fixed
Matt silver reflector



HEX-SBB

550.-

DIA 125x125 mm. H 170 mm.

 E27x1
 Sand black trim/ Black inside

IP 20

 Fixed
Matt silver reflector



HEX-MWW

650.-

DIA 145x145 mm. H 225 mm.

 E27x1
 Sand white trim/ White inside

IP 20

 Fixed
Matt silver reflector

HEX-MWB

700.-

DIA 145x145 mm. H 225 mm.

 E27x1
 Sand white trim/ Black inside

IP 20



 Fixed
Matt silver reflector



HEX-MBB

650.-

DIA 145x145 mm. H 225 mm.

 E27x1
 Sand black trim/ Black inside

IP 20

 Fixed
Matt silver reflector



HEX-SWW2

1150.-

DIA 125x255 mm. H 170 mm.



E27x2



Sand white trim/ White inside

IP 20



Adjustable

Matt silver reflector

HEX-SBB2

1150.-

DIA 125x255 mm. H 170 mm.



E27x2



Sand black trim/ Black inside

IP 20



Adjustable

Matt silver reflector





HEX-MWW2

1350.-

DIA 145x285 mm. H 225 mm.



E27x2



Sand white trim/ White inside

IP 20



Fixed

Matt silver reflector

HEX-MBB2

1350.-

DIA 145x285 mm. H 225 mm.



E27x2



Sand black trim/ Black inside

IP 20



Fixed

Matt silver reflector





LUXX-SWW

550.-

DIA 135 mm. H 170 mm.

 E27x1
 Sand white trim/ White inside

IP 20

 Fixed
Matt silver reflector

LUXX-SWB

600.-

DIA 135 mm. H 170 mm.

 E27x1
 Sand white trim/ Black inside

IP 20



 Fixed
Matt silver reflector



LUXX-SBB

550.-

DIA 135 mm. H 170 mm.

 E27x1
 Sand black trim/ Black inside

IP 20

 Fixed
Matt silver reflector





LUXX-MWW

650.-

DIA 155 mm. H 220 mm.

 E27x1
 Sand white trim/ White inside

IP 20

 Fixed
Matt silver reflector

LUXX-MWB

700.-

DIA 155 mm. H 220 mm.

 E27x1
 Sand white trim/ Black inside

IP 20



 Fixed
Matt silver reflector



LUXX-MBB

650.-

DIA 155 mm. H 220 mm.

 E27x1
 Sand black trim/ Black inside

IP 20

 Fixed
Matt silver reflector







COSMO-S

450.-

DIA 103 mm. H 145 mm.

 E27x1
 Sand white trim



IP 20

 Fixed
Matt silver reflector

COSMO-M

550.-

DIA 140 mm. H 155 mm.

 E27x1
 Sand white trim

IP 20



 Fixed
Matt silver reflector



COSMO-L

650.-

DIA 170 mm. H 180 mm.

 E27x1
 Sand white trim

IP 20



 Fixed
Matt silver reflector



DUFF-S1

400.-

DIA 128x128 mm. H 162 mm.

 E27x1
 Sand white trim



IP 20

 Fixed
Shiny silver reflector

DUFF-S2

700.-

DIA 128x237 mm. H 162 mm.

 E27x2
 Sand white trim

IP 20

 Fixed
Shiny silver reflector





DOWNLIGHT



TEDD-R

450.-

DIA 137 mm. H 160-190 mm.

 E27x1
 Matt white trim



IP 20

 Fixed
Matt white reflector

TEDD-S

600.-

DIA 133x133 mm. H 165-195 mm.

 E27x1
 Matt white trim

IP 20

 Fixed
Matt white reflector



DOWNLIGHT



DOME-MG

700.-

DIA 150 mm. H 190 mm.



E27x1
Sand white trim

IP 44

- Fixed
Matt silver reflector
Frosted glass cover

DOME-LG

800.-

DIA 175 mm. H 220 mm.



E27x1
Sand white trim

IP 44

- Fixed
Matt silver reflector
Frosted glass cover





DOWNLIGHT



VELL-S

700.-

DIA 125x125 mm. H 175 mm.

 E27x1
 Sand white trim



IP 44

 Fixed
Frosted glass cover

VELL-M

950.-

DIA 160x160 mm. H 175 mm.

 E27x1
 Sand white trim

IP 44

 Fixed
Frosted glass cover





DOWNLIGHT



DOME-M

150.-

DIA 146 mm. H 140 mm.

 E27x1
 Sand white trim



IP 20

 Fixed
Shiny silver reflector

DOME-L

200.-

DIA 177 mm. H 150 mm.

 E27x1
 Sand white trim

IP 20

 Fixed
Shiny silver reflector



A 4x5 grid of squares with a blue-to-white gradient. The top row is the lightest blue, and the bottom row is the darkest blue. The text is located in the bottom row of the grid.

***SURFACE MOUNTED
DOWNLIGHT***



CORE-R

900.-

DIA 96 mm. H 125 mm.

 GU10x1
Sand white/ Sand black

IP 20

 Adjustable
Accessories : Sling Hanging Wire Kit

CORE-S

900.-

DIA 96x96 mm. H 125 mm.

 GU10x1
Sand white/ Sand black

IP 20

 Adjustable
Accessories : Sling Hanging Wire Kit



DOWNLIGHT



MODE-RS

600.-

DIA 80 mm. H 95 mm.



GU10x1
Sand white/ Sand black

IP 20



Fixed
Accessories : Sling Hanging Wire Kit

MODE-SS

600.-

DIA 82.5x82.5 mm. H 95 mm.



GU10x1
Sand white/ Sand black

IP 20



Fixed
Accessories : Sling Hanging Wire Kit



DOWNLIGHT



MODE-RM

750.-

DIA 96 mm. H 127 mm.



PAR20x1
Sand white/ Sand black

IP 20



Fixed
Accessories : Sling Hanging Wire Kit

MODE-SM

750.-

DIA 100x100 mm. H 130 mm.



PAR20x1
Sand white/ Sand black

IP 20



Fixed
Accessories : Sling Hanging Wire Kit



DOWNLIGHT



MODE-RL

850.-

DIA 115 mm. H 137 mm.



PAR30Sx1
Sand white/ Sand black

IP 20



Fixed
Accessories : Sling Hanging Wire Kit

MODE-SL

850.-

DIA 120x120 mm. H 137 mm.



PAR30Sx1
Sand white/ Sand black

IP 20



Fixed
Accessories : Sling Hanging Wire Kit



DOWNLIGHT



MODE-RXL

1150.-

DIA 145 mm. H 175 mm.



PAR30L/ PAR38x1
Sand white/ Sand black

IP 20



Fixed

Accessories : Sling Hanging Wire Kit

MODE-SXL

1150.-

DIA 145x145 mm. H 175 mm.



PAR30L/ PAR38x1
Sand white/ Sand black

IP 20



Fixed

Accessories : Sling Hanging Wire Kit



DOWNLIGHT



CASE-S1 MR16

700.-

DIA 100x100 mm. H 115 mm.



MR16x1
Matt white/ Matt black

IP 20



Adjustable
Pull-out head
Accessories : Sling Hanging Wire Kit

CASE-S2 MR16

1250.-

DIA 100x200 mm. H 115 mm.



MR16x2
Matt white/ Matt black

IP 20



Adjustable
Pull-out head
Accessories : Sling Hanging Wire Kit



DOWNLIGHT



CASE-L1 AR111

1000.-

DIA 145×145 mm. H 160 mm.



AR111x1
Sand white/ Sand black

IP 20



Adjustable
Pull-out head
Accessories : Sling Hanging Wire Kit

CASE-L2 AR111

1850.-

DIA 145×278 mm. H 160 mm.



AR111x2
Sand white/ Sand black

IP 20



Adjustable
Pull-out head
Accessories : Sling Hanging Wire Kit



DOWNLIGHT



CASE-PR1 PAR30

1200.-

DIA 155×155 mm. H 200 mm.



PAR30S/ PAR30Lx1
Sand white/ Sand black

IP 20



Adjustable
Accessories : Sling Hanging Wire Kit

CASE-PR2 PAR30

2000.-

DIA 155×320 mm. H 200 mm.



PAR30S/ PAR30Lx2
Sand white/ Sand black

IP 20



Adjustable
Accessories : Sling Hanging Wire Kit



DOWNLIGHT



CASE-S1 E27

800.-

DIA 120×120 mm. H 180 mm.



E27x1
Sand white/ Sand black

IP 20



Adjustable
Accessories : Sling Hanging Wire Kit

CASE-S2 E27

1500.-

DIA 120×260 mm. H 180 mm.



E27x2
Sand white/ Sand black

IP 20



Adjustable
Accessories : Sling Hanging Wire Kit



DOWNLIGHT



CASE-L1 E27

1000.-

DIA 120×120 mm. H 180 mm.



E27x1



Sand white/ Sand black

IP 20



Adjustable

Accessories : Sling Hanging Wire Kit

CASE-L2 E27

1850.-

DIA 120×260 mm. H 180 mm.



E27x2



Sand white/ Sand black

IP 20



Adjustable

Accessories : Sling Hanging Wire Kit



DOWNLIGHT



NORI

1500.-

DIA 85 mm. H 70 mm.



LED COB 10W 890lm

3000K, 4000K

Matt white/ matt black

IP 20



Adjustable

Accessories : Sling Hanging Wire Kit

Aluminium Body

Driver included

Non-Dim

REEL

2400.-

DIA 115 mm. H 135 mm.



LED COB 20W 1890lm

3000K, 4000K

Matt white/ matt black

IP 20



Fixed

Accessories : Sling Hanging Wire Kit

Aluminium Body

Driver included

Non-Dim



DOWNLIGHT



JAZZ

800.-

DIA 70 mm. H 55 mm.



LED COB 7W 550lm

3000K, 4000K

Matt white/ matt black

IP 20



Fixed

Accessories : Sling Hanging Wire Kit

Aluminium Body

Driver included

Non-Dim

MOON

1000.-

DIA 140 mm. H 75 mm.



LED SMD 15W 1312lm

3000K, 4000K

Matt white/ matt black

IP 20



Fixed

Accessories : Sling Hanging Wire Kit

Aluminium Body

Driver included

Non-Dim



DOWNLIGHT

BENITO-M

1500.-

DIA 33x60 mm. L 270 mm.



LED SMD 10W 890lm

3000K, 4000K
Matt white/ matt black

IP 20



Fixed
Aluminium Body
Driver included
Non-Dim

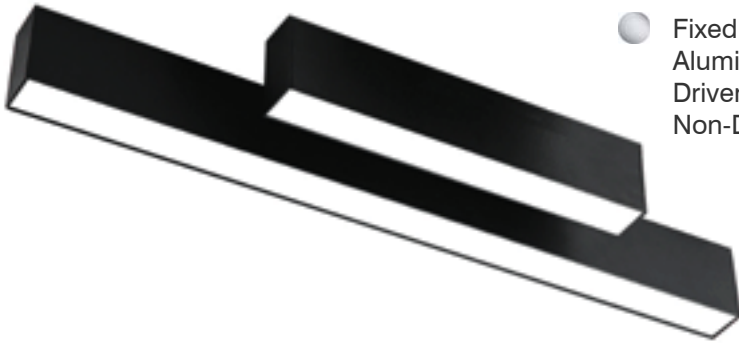

BENITO-L

2500.-

DIA 33x60 mm. L 535 mm.



LED SMD 20W 1780lm

3000K, 4000K
Matt white/ matt black

IP 20



Fixed
Aluminium Body
Driver included
Non-Dim

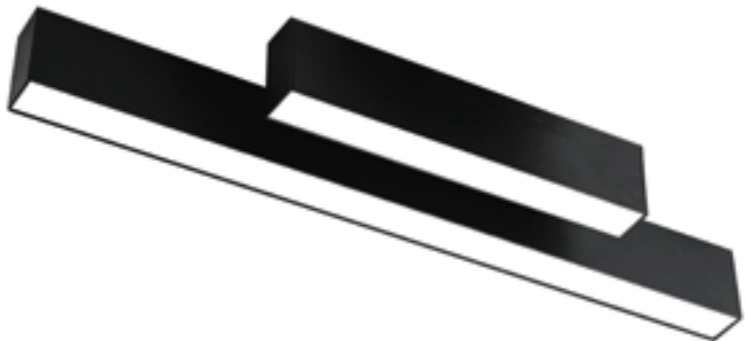

DOWNLIGHT

BETINI-M

1500.-

DIA 33x60 mm. L 270 mm.



LED COB 10x1W 890lm



3000K, 4000K

Matt white/ matt black

IP 20



Fixed

Aluminium Body

Driver included

Non-Dim



BETINI-L

2500.-

DIA 33x60 mm. L 535 mm.



LED COB 20x1W 1780lm



3000K, 4000K

Matt white/ matt black

IP 20



Fixed

Aluminium Body

Driver included

Non-Dim



DOWNLIGHT



ADEN-S

2000.-

DIA 37x135 mm. H 60 mm.



LED COB 5x2W 800lm

3000K, 4000K
Matt black

IP 20

- Surface mounted type
Adjustable 1 side
Aluminium Body
Driver included
Non-Dim

ADEN-M

3000.-

DIA 37x270 mm. H 60 mm.



LED COB 10x2W 1600lm

3000K, 4000K
Matt black

IP 20

- Surface mounted type
Adjustable 1 side
Aluminium Body
Driver included
Non-Dim



ADEN-L

4000.-

DIA 37x405 mm. H 60 mm.



LED COB 15x2W 2400lm

3000K, 4000K
Matt black

IP 20

- Surface mounted type
Adjustable 1 side
Aluminium Body
Driver included
Non-Dim



DOWNLIGHT



***LED STRIPLIGHT
& ACCESSORIES***



SMD3528 4.8W/M.

300.-

DIA 10 mm. H 4 mm.

60led/m.
24V 4.8w/m. 400Lumen/m.

IP 65

3000K, 4000K
Dimmable (0-10V/ Triac) Optional

SMD3528 9.6W/M.

450.-

DIA 10 mm. H 4 mm.

120led/m.
24V 9.6w/m. 800Lumen/m.

IP 65

2700K, 3000K, 4000K
Dimmable (0-10V/ Triac) Optional



SMD3528 14.4W/M.

500.-

DIA 10 mm. H 4 mm.

168led/m. Cutting length 100mm.
24V 9.6w/m. 1200Lumen/m.

IP 65

2700K, 3000K, 4000K, 6000K
Dimmable (0-10V/ Triac) Optional



LED STRIPLIGHT

**SMD3528 19.2W/M.****600.-**

DIA 10 mm. H 2 mm.

168led/m.
24V 19.2w/m. 1600Lumen/m.**IP 20**3000K, 4000K
Dimmable (0-10V/ Triac) Optional**SMD3528 28.8W/M.****800.-**

DIA 10 mm. H 2 mm.

120led/m.
24V 28w/m. 2400Lumen/m.**IP 20**3000K, 4000K, 6000K
Dimmable (0-10V/ Triac) Optional



SMD5050 7.2W/M.

350.-

DIA 12 mm. H 4 mm.



30led/m.
12V 7.2w/m. 600Lumen/m.

IP 65



2700K, 3000K, 4000K
Dimmable (0-10V/ Triac) Optional

SMD5050 14.4W/M.

200.-

DIA 10 mm. H 4 mm.



60led/m.
12V/24V 14.4w/m. 1200Lumen/m.

IP 20



3000K, 4000K, 6500K
Dimmable (0-10V/ Triac) Optional



SMD5050 14.4W/M.

500.-

DIA 12 mm. H 4 mm.



60led/m.
12V/24V 14.4w/m. 1200Lumen/m.

IP 65



2700K, 3000K, 4000K
Dimmable (0-10V/ Triac) Optional



LED STRIPLIGHT



SMD5050 RGB

600.-

DIA 12 mm. H 4 mm.

60led/m.
24V 14.4w/m.

IP 65

- RGB Color change
Use with RGB controller

SMD5050 RGBW

650.-

DIA 14 mm. H 4 mm.

60led/m.
24V 19.2w/m.

IP 65

- RGB+3000K
Use with RGBW controller



SMD5050 CCT

650.-

DIA 12 mm. H 4 mm.

60led/m.
24V 14.4w/m.

IP 65

- CCT 2700K-6500K
Use with CCT controller



LED STRIPLIGHT



COB 10W/M.

500.-

DIA 5 mm. H 2 mm.

 LED COB
24V 10w/m. 800Lumen/m.

IP 20

-  3000K, 4000K, 6000K
Dimmable (0-10V/ Triac) Optional

COB RGB 14W/M.

600.-

DIA 10 mm. H 2 mm.

 LED COB RGB
24V 14w/m.

IP 20

-  RGB Color change
Use with RGB controller



CCT

COB CCT 14W/M.

600.-

DIA 8 mm. H 2 mm.

 LED COB CCT
24V 14w/m.

IP 20

-  CCT 2700K-6500K
Use with CCT controller



LED STRIPLIGHT

NEONFLEX NS1617

1200.-

DIA 16 mm. H 17 mm.



168led/m.
24V 15w/m. 800Lumen/m.

IP 67



2700K, 3000K, 4000K, 6000K

Side Bending

Stainless steel clip/ Flexible stainless steel clip

IP68 optional

Dimmable (0-10V/ Triac) Optional

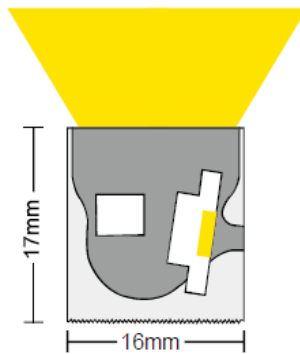

NEONFLEX NT1515

1200.-

DIA 15 mm. H 15 mm.



168led/m.
24V 15w/m. 800Lumen/m.

IP 67



2700K, 3000K, 4000K, 6000K

Top Bending

Stainless steel clip/ Flexible stainless steel clip

IP68 optional

Dimmable (0-10V/ Triac) Optional

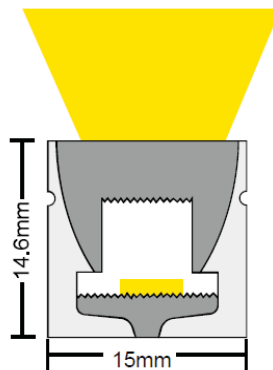

LED STRIPLIGHT

NEONFLEX NS1220

1200.-

DIA 12 mm. H 20 mm.



168led/m.
24V 15w/m. 800Lumen/m.

IP 67



2700K, 3000K, 4000K, 6000K

Side Bending

Aluminium clip/ Flexible stainless steel clip

IP68 optional

Dimmable (0-10V/ Triac) Optional

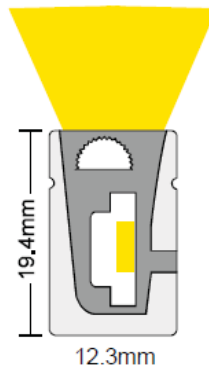

NEONFLEX NS0612

1000.-

DIA 6 mm. H 12 mm.



168led/m.
24V 10w/m.500Lumen/m.

IP 67



2700K, 3000K, 4000K, 6000K

Side Bending

Aluminium clip/ Flexible stainless steel clip

IP68 optional

Dimmable (0-10V/ Triac) Optional

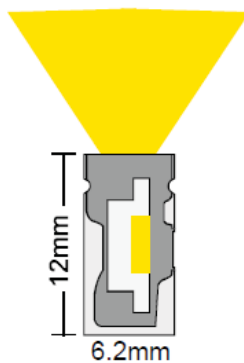

LED STRIPLIGHT

NEONFLEX NS1212

1000.-

DIA 12 mm. H 12 mm.

168led/m.
24V 10w/m. 500Lumen/m.

IP 67

- 2700K, 3000K, 4000K, 6000K
Side Bending
Stainless steel clip/ Flexible stainless steel clip
IP68 optional
Dimmable (0-10V/ Triac) Optional

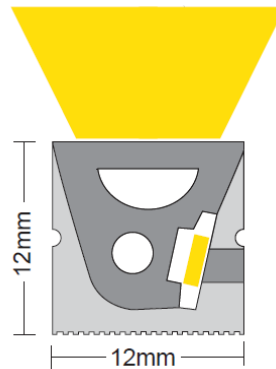

NEONFLEX NT1212

1000.-

DIA 12 mm. H 12 mm.

168led/m.
24V 10w/m. 500Lumen/m.

IP 67

- 2700K, 3000K, 4000K, 6000K
Top Bending
Stainless steel clip/ Flexible stainless steel clip
IP68 optional
Dimmable (0-10V/ Triac) Optional

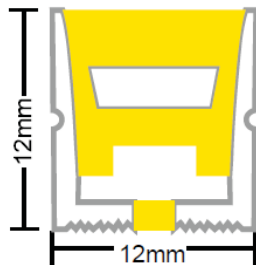

LED STRIPLIGHT



TYPE-A

350.-

DIA 23.1 mm. H 8.5 mm. L 1000 mm.

- Recessed type
- Frosted PC cover

IP 20

- Accessories : End cap

TYPE-B

350.-

DIA 17.1 mm. H 8.5 mm. L 1000 mm.

- Recessed/ Surface type
- Frosted PC cover

IP 20

- Accessories : Mounting clip, End cap





TYPE-C

400.-

DIA 23.2 mm. H 15.3 mm. L 1000 mm.

-  Recessed type
-  Frosted PC cover



IP 20

-  Accessories : End cap

TYPE-D

400.-

DIA 17.1 mm. H 15.3 mm. L 1000 mm.

-  Recessed/ Surface type
-  Frosted PC cover

IP 20

-  Accessories : Mounting clip, End cap





TYPE-E

400.-

DIA 16 mm. H 16 mm. L 1000 mm.

 Surface type
 Frosted PC cover



IP 20

 Accessories : Mounting clip, End cap

TYPE-F

900.-

DIA 21.3 mm. H 26.1 mm. L 1000 mm.

 Floor recessed type
 Frosted PC cover

IP 20

 Accessories : End cap



ALU. PROFILE



TYPE-G1

1300.-

DIA 65 mm. H 35 mm. L 1000 mm.

- Recessed type
- Frosted PC cover

IP 20

- Accessories : Spring clip, End cap

TYPE-G2

1300.-

DIA 50 mm. H 35 mm. L 1000 mm.

- Surface/ Hanging type
- Frosted PC cover

IP 20

- Accessories : Mounting clip, End cap,
Sling for hanging type





TYPE-H1

1050.-

DIA 50 mm. H 35 mm. L 1000 mm.

 Recessed type
 Frosted PC cover



IP 20

 Accessories : Spring clip, End cap

TYPE-H2

1050.-

DIA 35 mm. H 35 mm. L 1000 mm.

 Surface/ Hanging type
 Frosted PC cover

IP 20

 Accessories : Mounting clip, End cap,
Sling for hanging type





TYPE-J1

1650.-

DIA 90 mm. H 35 mm. L 1000 mm.

 Recessed type
 Frosted PC cover



IP 20

 Accessories : Spring clip, End cap

TYPE-J2

1650.-

DIA 75 mm. H 35 mm. L 1000 mm.

 Surface/ Hanging type
 Frosted PC cover

IP 20

 Accessories : Mounting clip, End cap
Sling for hanging type





TYPE-K1

800.-

DIA 35 mm. H 25 mm. L 1000 mm.

 Recessed type
 Frosted PC cover



IP 20

 Accessories : Spring clip, End cap

TYPE-K2

800.-

DIA 25 mm. H 25 mm. L 1000 mm.

 Recessed/ Surface type
 Frosted PC cover

IP 20

 Accessories : Mounting clip, End cap



ALU. PROFILE



TYPE-M

600.-

DIA 25.4 mm. H 28 mm. L 1000 mm.

 Surface type
 Frosted PC cover

IP 20

 Accessories : Mounting clip, End cap

TYPE-N

600.-

DIA 25.4 mm. H 28 mm. L 1000 mm.

 Surface type
 Frosted PC cover

IP 20

 Accessories : Mounting clip, End cap





TYPE-OA

3550.-

DIA 60 mm. H 90 mm. L 1000 mm.



Surface/ Hanging type
Frosted PC cover

IP 20

- Accessories : Mounting clip, End cap, Sling for hanging type

TYPE-OB

2950.-

DIA 68 mm. H 75 mm. L 1000 mm.



Recessed type
Frosted PC cover

IP 20

- Accessories : Spring clip, End cap



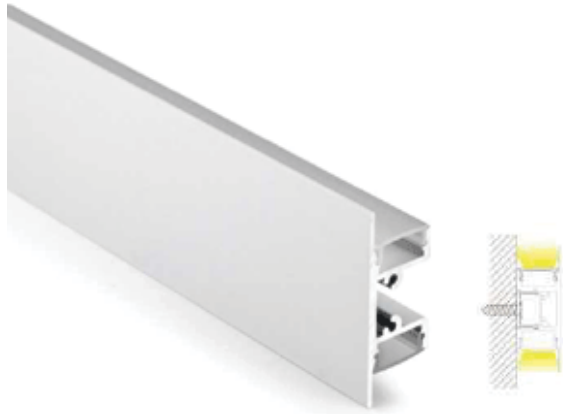

TYPE-Q

1200.-

DIA 48.5 mm. H 17.7 mm. L 1000 mm.



Wall surface type
Frosted PC cover
Up & Down light

IP 20



Accessories : End cap

TYPE-S

1000.-

DIA 43.5 mm. H 17.7 mm. L 1000 mm.



Wall surface type
Frosted PC cover
Up or Down light

IP 20



Accessories : End cap



ALU. PROFILE



TYPE-U1

350.-

DIA 12.8 mm. H 12 mm. L 1000 mm.



Recessed type

Frosted PC cover

Use with 5mm. led strip only

IP 20



Accessories : End cap

TYPE-U2

350.-

DIA 7.8 mm. H 12 mm. L 1000 mm.



Surface type

Frosted PC cover

Use with 5mm. led strip only

IP 20



Accessories : Mounting clip, End cap





TYPE-X

450.-

DIA 10 mm. H 10 mm. L 1000 mm.



Surface type
Frosted PC cover
Use with 5mm. led strip only

IP 20



Accessories : Mounting clip, End cap

TYPE-T

350.-

DIA 8 mm. H 8 mm. L 1000 mm.



Surface type
Frosted PC cover
Use with 5mm. led strip only

IP 20



Accessories : Mounting clip, End cap

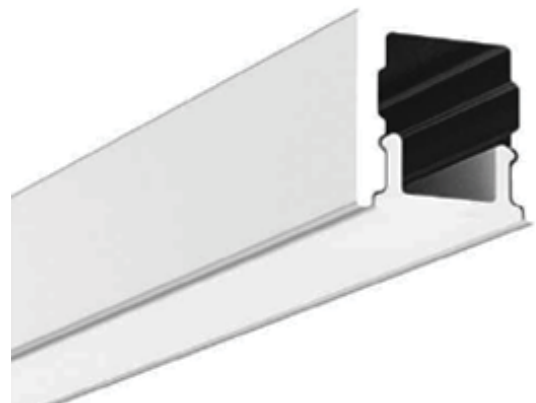

ALU. PROFILE



TYPE-R1

1750.-

DIA 65 mm. H 45 mm. L 1000 mm.

- Recessed type
- Frosted PC cover

IP 20

- Accessories : Spring clip, End cap

TYPE-R2

2450.-

DIA 50 mm. H 75 mm. L 1000 mm.

- Surface/ Hanging type
- Frosted PC cover

IP 20

- Accessories : Mounting clip, End cap



ALU. PROFILE

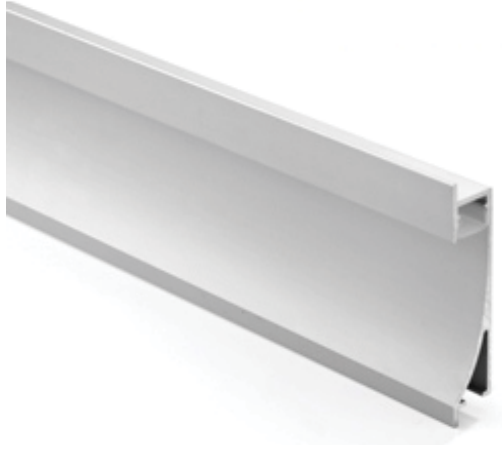

TYPE-W

1300.-

DIA 14 mm. H 68 mm. L 1000 mm.

- Wall recessed type
- Frosted PC cover

IP 20

- Accessories : End cap

TYPE-L

4000.-

DIA 60 mm. L 2000 mm.

- Surface/ Hanging type
- Frosted PC cover

IP 20

- Accessories : Mounting clip, End cap, Sling for hanging type





TYPE-P

400.-

DIA 12 mm. H 20 mm. L 1000 mm.

 Surface type
 Frosted PC cover



IP 20

 Accessories : Mounting clip, End cap

TYPE-Z

2000.-

DIA 35.2 mm. H 66.8 mm. L 1000 mm.

 Surface/ Hanging type
 Frosted PC cover

IP 20

 Accessories : Mounting clip, End cap

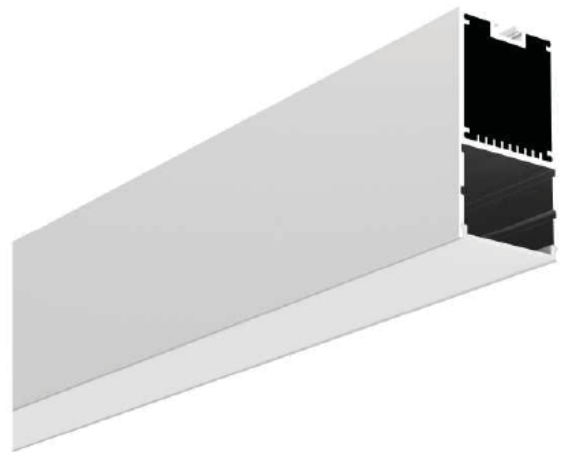



ALU. PROFILE



R6-1

1500.-

DIA 58.5×107 mm. D: 9 mm.

 Dimming remote control 1zone
 CR2032 Battery



 Use with V3-L, V4-L Controller



R8-1

1500.-

DIA 58.5×107 mm. D: 9 mm.

 RGB/ RGBW remote control 1zone
 CR2032 Battery

 Use with V3-L, V4-L Controller





CONTROLLER



R9

1500.-

DIA 58.5×107 mm. D: 9 mm.

 RGB/ RGBW remote control 1zone
 CR2032 Battery



 Use with V3-L, V4-L Controller



R7-1

1500.-

DIA 58.5×107 mm. D: 9 mm.

 CCT remote control 1zone
 CR2032 Battery

 Use with V3-L, V4-L Controller





CONTROLLER



RT-6

1800.-

DIA 53×122 mm. D: 17.5 mm.

 Dimming remote control 4zone
 CR2032 Battery



 Use with V3-L, V4-L Controller



RT9

1800.-

DIA 53×122 mm. D: 17.5 mm.

 RGB/ RGBW remote control 4zone
 CR2032 Battery



 Use with V3-L, V4-L Controller



RT7

1800.-

DIA 53×122 mm. D: 17.5 mm.

 CCT remote control 4zone
 CR2032 Battery

 Use with V3-L, V4-L Controller





T21-1

2500.-

DIA 53×122 mm. D: 17.5 mm.

- Dimming touch panel 4zone
- AAAx2 Battery

Use with V3-L, V4-L Controller



T24-1

2500.-

DIA 53×122 mm. D: 17.5 mm.

- RGB/ RGBW touch panel 4zone
- AAAx2 Battery

Use with V3-L, V4-L Controller



T22-1

2500.-

DIA 53×122 mm. D: 17.5 mm.

- CCT touch panel 4zone
- AAAx2 Battery

Use with V3-L, V4-L Controller



CONTROLLER



V3-L

1500.-

DIA 45x175 mm. H 27 mm.



RGB/CCT/Dimming controller

12-24Vdc

Max load 216W(12Vdc), 432W(24Vdc)



RF 2.4GHz

Use with R6-1, R8-1, R7-1, R9, RT6,
RT7, RT9, T21-1, T22-1, T24-1



SCAN ME

V4-L

1800.-

DIA 50x170 mm. H 23 mm.



RGBW/RGB/CCT/Dimming controller

12-24Vdc

Max load 240W(12Vdc), 480W(24Vdc)



RF 2.4GHz

Use with R6-1, R8-1, R7-1, R9, RT6,
RT7, RT9, T21-1, T22-1, T24-1



SCAN ME



CONTROLLER

EV3-X

1500.-

DIA 75x107 mm. H 24.5 mm.



RGB/CCT/Dimming signal repeater

12-24Vdc

Max load 360W(12Vdc), 720W(24Vdc)



3 channel, 10A per channel



EV4-X

1750.-

DIA 75x107 mm. H 24.5 mm.



RGBW/RGB/CCT/Dimming signal repeater

12-24Vdc

Max load 384W(12Vdc), 768W(24Vdc)



4 channel, 8A per channel



CONTROLLER

V1-T

2000.-



DIA 75x107 mm. H 24.5 mm.



Dimming controller

12-24Vdc

Max load 240W(12Vdc), 480W(24Vdc)



RF 2.4GHz use with R6-1, T21-1

0-10V Dimming controller/ Push-dim



V1-K

2000.-

DIA 75x107 mm. H 38 mm.



Dimming controller

12-24Vdc

Max load 240W(12Vdc), 480W(24Vdc)



RF 2.4GHz use with R6-1, T21-1

Dim switch built-in



CONTROLLER

Aluminium case IP20

12Vdc Switching power supply



12V 15W	Size : 85x58x33 mm.	450.-
12V 36W	Size : 85x58x33 mm.	750.-
12V 60W	Size : 139x55x28 mm.	1050.-
12V 100W	Size : 139x55x28 mm.	1250.-
12V 150W	Size : 178x61x28 mm.	1500.-
12V 200W	Size : 178x61x28 mm.	2000.-
12V 250W	Size : 160x98x30 mm.	2250.-
12V 360W	Size : 215x105x30 mm.	2500.-

Plastic case IP20

12Vdc Switching power supply

12V 15W	Size : 100x30x22 mm.	450.-
12V 36W	Size : 145x34x22 mm.	750.-
12V 60W	Size : 176x43x25 mm.	1050.-



Aluminium case IP67

12/24Vdc Switching power supply



12V/ 24V 200W Size : 237x60x33 mm. **2400.-**

12V/ 24V 250W Size : 240x72x33 mm. **3000.-**

12V/ 24V 300W Size : 240x72x33 mm. **3600.-**

Plastic case IP67

12/24Vdc Switching power supply

12V/ 24V 35W Size : 151x40x30 mm. **900.-**

12V/ 24V 60W Size : 165x42x32 mm. **1250.-**

12V/ 24V 150W Size : 192x52x37 mm. **1750.-**





Mean well LRS IP20

12/24Vdc Switching power supply

12V/ 24V 25W	Size : 78x51x28 mm.	700.-
12V/ 24V 35W	Size : 82x99x30 mm.	800.-
12V/ 24V 50W	Size : 139x55x28 mm.	850.-
12V/ 24V 75W	Size : 139x55x28 mm.	1040.-
12V/ 24V 100W	Size : 178x61x28 mm.	1160.-
12V/ 24V 150W	Size : 178x61x28 mm.	1360.-
12V/ 24V 200W	Size : 160x98x30 mm.	1680.-
12V/ 24V 360W	Size : 215x105x30 mm.	2100.-



Mean well LPV IP67

12/24Vdc Switching power supply

12V/ 24V 35W	Size : 148x40x30 mm.	1000.-
12V/ 24V 60W	Size : 162.5x42.5x32 mm.	1100.-
12V/ 24V 100W	Size : 190x52x37 mm.	1700.-
12V/ 24V 150W	Size : 191x63x37.5 mm.	2600.-



TRANSFORMER

CC LED DRIVER IP20

Constant current led driver

3-12Vdc 350mA Size : 42x40x21 mm. **400.-**

3-12Vdc 700mA Size : 42x40x21 mm. **400.-**



CC LED DRIVER IP65

Constant current led driver



2.5-4Vdc 700mA Size : 52.5×26.5×21mm. **500.-**





EUP75A-1W24V-1

DIA 54×213 mm. H 33 mm.

 Constant voltage dimmable driver
 24V 75W

 Use with 0-10V Dimming system



EUP150A-1W24V-1

DIA 74.8×206 mm. H 40.6 mm.

 Constant voltage dimmable driver
 24V 150W

 Use with 0-10V Dimming system



EUP200AD-1H24V-0

DIA 60×310 mm. H 45 mm.

 Constant voltage dimmable driver
 24V 200W

 Use with 0-10V Dimming system





EUP75T-1H24V-0

DIA 53.9×212.5 mm. H 36 mm.



 Constant voltage dimmable driver
 24V 75W

 Use with Triac/ Phase-cut Dimming system



EUP150T-1H24V-0

DIA 60×310 mm. H 45 mm.

 Constant voltage dimmable driver
 24V 150W

 Use with Triac/ Phase-cut Dimming system



EUP200T-1H24V-0

DIA 60×310 mm. H 45 mm.

 Constant voltage dimmable driver
 24V 200W

 Use with Triac/ Phase-cut Dimming system



LED DRIVER



EUP75D-1H24V-0

DIA 54×213 mm. H 33 mm.



 Constant voltage dimmable driver
 24V 75W

 Use with DALI Dimming system



EUP150D-1W24V-0

DIA 74.8×206 mm. H 40.6 mm.

 Constant voltage dimmable driver
 24V 150W

 Use with DALI Dimming system



EUP200AD-1W24V-0

DIA 60×310 mm. H 45 mm.

 Constant voltage dimmable driver
 24V 200W

 Use with DALI Dimming system





EUP10A-1HMC-1-120

DIA 110*30*22 mm.

- Constant current dimmable driver
- 9-42Vdc Max. 10W
- 120-350mA

- Use with 0-10V Dimming system



EUP10A-1HMC-1-350

DIA 110*30*22 mm.

- Constant current dimmable driver
- 2-21Vdc Max. 10W
- 350-700mA

- Use with 0-10V Dimming system



EUP15A-1HMC-1

DIA 150*43*22 mm.

- Constant current dimmable driver
- 9-42Vdc Max. 15W
- 280-450mA



- Use with 0-10V Dimming system





EUP20A-1HMC-1

DIA 150*43*22 mm.



 Constant current dimmable driver
 9-40Vdc Max. 20W
350-700mA

 Use with 0-10V Dimming system



EUP30A-1HMC-1

DIA 150*43*22 mm.



 Constant current dimmable driver
 9-45Vdc Max. 30W
550-900mA

 Use with 0-10V Dimming system



EUP40A-1HMC-1

DIA 137*81.5*31 mm.

 Constant current dimmable driver
 9-45Vdc Max. 40W
850-1200mA

 Use with 0-10V Dimming system



EUP10T-1HMC-1-120

DIA 110*30*22 mm.



- Constant current dimmable driver
- 9-42Vdc Max. 10W
- 120-350mA

- Use with Triac/ Phase-cut Dimming system



EUP10T-1HMC-1-350

DIA 110*30*22 mm.

- Constant current dimmable driver
- 2-21Vdc Max. 10W
- 350-700mA

- Use with Triac/ Phase-cut Dimming system



EUP15T-1HMC-0

DIA 150*43*22 mm.

- Constant current dimmable driver
- 9-42Vdc Max. 15W
- 280-450mA

- Use with Triac/ Phase-cut Dimming system





EUP20T-1HMC-0

DIA 150*43*22 mm.

- Constant current dimmable driver
- 9-40Vdc Max. 20W
- 350-700mA

Use with Triac/ Phase-cut Dimming system



EUP30T-1HMC-0

DIA 185*43*29 mm.

- Constant current dimmable driver
- 9-45Vdc Max. 30W
- 600-900mA

Use with Triac/ Phase-cut Dimming system



EUP45T-1HMC-0

DIA 137*82*31 mm.

- Constant current dimmable driver
- 33-65Vdc Max. 45W
- 500-1050mA



Use with Triac/ Phase-cut Dimming system



EUP10D-1HMC-0-120

DIA 110*30*22 mm.





-  Constant current dimmable driver
-  9-45Vdc Max. 10W
- 120-300mA

-  Use with DALI Dimming system



EUP10D-1HMC-0-350

DIA 110*30*22 mm.

-  Constant current dimmable driver
-  2-21Vdc Max. 10W
- 350-700mA



-  Use with DALI Dimming system



EUP12D-1HMC-0

DIA 150*43*22 mm.



-  Constant current dimmable driver
-  9-40Vdc Max. 12W
- 200-350mA

-  Use with DALI Dimming system





EUP20D-1HMC-0

DIA 150*43*22 mm.

- Constant current dimmable driver
- 9-40Vdc Max. 20W
- 350-700mA

- Use with DALI Dimming system



EUP30D-1HMC-0

DIA 150*43*29 mm.

- Constant current dimmable driver
- 9-45Vdc Max. 30W
- 550-900mA

- Use with DALI Dimming system



EUP40D-1HMC-0

DIA 137*82*31 mm.

- Constant current dimmable driver
- 9-45Vdc Max. 40W
- 850-1200mA

- Use with DALI Dimming system





OSRAM Driver LVED PRO 30

DIA 87x35x24mm.

 Constant current driver
25-42Vdc Max. 30W
450-700mA

 Non-dim Driver
0.95 PF
THD 15%



OSRAM Driver LVED PRO 40

DIA 146x40x27mm.

 Constant current driver
25-42Vdc Max. 40W
700-950mA

 Non-dim Driver
0.95 PF
THD 15%



LED DRIVER

OSRAM Driver LVED PRO 12

DIA 97x40x27mm.

 Constant current driver
25-42Vdc Max. 12W
120-300mA

 Non-dim Driver
0.95 PF
THD 15%



OSRAM Driver LVED PRO 20

DIA 87x35x24mm.

 Constant current driver
25-42Vdc Max. 20W
250-500mA

 Non-dim Driver
0.95 PF
THD 15%



LED DRIVER

The image features a 5x4 grid of squares. The top row consists of four squares with a light blue-to-white gradient. The second row consists of four squares with a light blue-to-white gradient. The third row consists of four squares with a medium blue-to-white gradient. The fourth row consists of four squares with a medium blue-to-white gradient. The bottom row consists of four squares with a dark blue-to-white gradient. The text "TRACK LIGHT" is written in white, bold, italicized capital letters in the bottom right corner of the grid.

TRACK LIGHT



MARC-B

850.-

DIA 60 mm. H 130 mm.

 GU10x1
Matt white/ Matt black

IP 20

 Surface mounted type
Aluminium Body

MARC-T

850.-

DIA 60 mm. H 130 mm.

 GU10x1
Matt white/ Matt black

IP 20

 Aluminium Body
Use with 1 phase track only



TRACK LIGHT



BIT **450.-**

DIA 58 mm. H: 75 mm.

 GU10x1
Matt white/ Matt black

IP 20

 Aluminium Body
Use with 1 phase track only

MATTY **750.-**

DIA 55 mm. H: 100 mm.

 GU10x1
Matt white/ Matt black

IP 20

 Aluminium Body
Use with 1 phase track only



MINN **750.-**

DIA 60 mm. H: 112 mm.

 GU10x1
Matt white/ Matt black

IP 20

 Surface mounted type
Aluminium Body



TRACK LIGHT



ASTER-S

1200.-

DIA 65 mm. H: 120 mm.



MR16x1
Matt white/ Matt black

IP 20

- Aluminium Body
Driver not included
Use with 1 phase track only

TEMP

750.-

DIA 55 mm. H: 115 mm.



MR16x1
Matt white/ Matt black

IP 20

- Aluminium Body
Driver not included
Use with 1 phase track only



MICK

750.-

DIA 60 mm. H: 150 mm.



GU10x1
Matt white/ Matt black

IP 20

- Aluminium Body
Use with 1 phase track only

TRACK LIGHT



ASTER-M

2000.-

DIA 77 mm. H 182 mm.



LED COB 20W 1600lm

3000K, 4000K, 6000K
Matt white/ Matt black

IP 20



Aluminium Body

Driver included

Non-Dim

Use with 1 phase track only

ASTER-L

2500.-

DIA 85 mm. H 182 mm.



LED COB 30W 2400lm

3000K, 4000K, 6000K
Matt white/ Matt black

IP 20



Aluminium Body

Driver included

Non-Dim

Use with 1 phase track only



TRACK LIGHT



GEO-S

550.-

DIA 80 mm. H 110 mm.



PAR20x1
Matt white/ Matt black

IP 20



Aluminium Body
Use with 1 phase track only

GEO-L

600.-

DIA 100 mm. H 140 mm.



PAR30Lx1
Matt white/ Matt black

IP 20



Aluminium Body
Use with 1 phase track only



TRACK LIGHT

**BASKET****600.-**

DIA 80 mm. H 110 mm.

 PAR30x1
Matt white/ Matt black

IP 20

 Aluminium Body
Use with 1 phase track only

GROOVE**600.-**

DIA 100 mm. H 140 mm.

 PAR30Lx1
Matt white/ Matt black

IP 20

 Aluminium Body
Use with 1 phase track only





NITRO-S

750.-

DIA 65 mm. H 102 mm.



LED COB 10W 800lm

3000K, 4000K, 6500K
Matt white/ Matt black

IP 20



Aluminium Body

Driver included

Non-Dim

Use with 1 phase track only

NITRO-M

1500.-

DIA 90 mm. H 185 mm.



LED COB 20W 1600lm

3000K, 4000K, 6500K
Matt white/ Matt black

IP 20



Aluminium Body

Driver included

Non-Dim

Use with 1 phase track only



NITRO-L

2000.-

DIA 90 mm. H 185 mm.



LED COB 30W 2400lm

3000K, 4000K, 6500K
Matt white/ Matt black

IP 20



Aluminium Body

Driver included

Non-Dim

Use with 1 phase track only



TRACK LIGHT



IRIS-S

1000.-

DIA 66 mm. H 135 mm.



LED COB 10W 800lm

3000K, 4000K, 6500K
Matt white/ Matt black

IP 20



Aluminium Body

Driver included

Non-Dim

Use with 1 phase track only

IRIS-M

1500.-

DIA 76 mm. H 138 mm.



LED COB 20W 1600lm

3000K, 4000K, 6500K
Matt white/ Matt black

IP 20



Aluminium Body

Driver included

Non-Dim

Use with 1 phase track only



IRIS-L

2000.-

DIA 88 mm. H 146 mm.



LED COB 30W 2400lm

3000K, 4000K, 6500K
Matt white/ Matt black

IP 20



Aluminium Body

Driver included

Non-Dim

Use with 1 phase track only

TRACK LIGHT



VIRNEA-XS

800.-

DIA 55 mm. H 90 mm.



LED COB 7W 560lm



3000K

Matt white/ Matt black

IP 20

- Aluminium Body
- Driver included
- Non-Dim
- Use with 1 phase track only

VIRNEA-S

1500.-

DIA 65 mm. H 110 mm.



LED COB 12W 1050lm



3000K, 4000K

Matt white/ Matt black

IP 20

- Aluminium Body
- Driver included
- Non-Dim
- Use with 1 phase track only



TRACK LIGHT



VIRNEA-M

1850.-

DIA 75 mm. H 130 mm.



LED COB 20W 1440lm



3000K, 4000K, 6000K
Matt white/ Matt black

IP 20

- Aluminium Body
- Driver included
- Non-Dim
- Use with 1 phase track only

VIRNEA-L

2250.-

DIA 95 mm. H 140 mm.



LED COB 30W 2400lm



3000K, 4000K, 6000K
Matt white/ Matt black

IP 20

- Aluminium Body
- Driver included
- Non-Dim
- Use with 1 phase track only



TRACK LIGHT



COWELL

2500.-

DIA 115×25 mm. H: 135 mm.



LED COB 12W 1080lm

3000K, 4000K

Matt white/ Matt black

IP 20



Aluminium Body

Driver included

Non-Dim

Use with 1 phase track only

META-T

1350.-

DIA 67x61 mm. H: 59 mm.



LED COB 8W 715lm

3000K, 4000K

Matt white/ Matt black

IP 20



Aluminium Body

Driver included

Non-Dim

Use with 1 phase track only



META-B

1350.-

DIA 67x61mm. H: 59mm.



LED COB 8W 715lm

3000K, 4000K

Matt white/ Matt black

IP 20



Surface mounted type

Aluminium Body

Driver included

Non-Dim

TRACK LIGHT



TOYO-S

1500.-

DIA 50 mm. H 140 mm.



LED COB 12W 960lm

3000K, 4000K, 6500K
Matt white/ Matt black

IP 20

- Adjustable beam angle 15D-60D
- Aluminium Body
- Driver included
- Non-Dim
- Use with 1 phase track only

TOYO-M

2000.-

DIA 75 mm. H 165 mm.



LED COB 20W 1600lm

3000K, 4000K, 6500K
Matt white/ Matt black

IP 20

- Adjustable beam angle 15D-60D
- Aluminium Body
- Driver included
- Non-Dim
- Use with 1 phase track only



TOYO-L

2500.-

DIA 75 mm. H 165 mm.



LED COB 30W 2400lm

3000K, 4000K, 6500K
Matt white/ Matt black

IP 20

- Adjustable beam angle 15D-60D
- Aluminium Body
- Driver included
- Non-Dim
- Use with 1 phase track only

TRACK LIGHT



VIVA-S1

600.-

DIA 60 mm. H: 120 mm.

 GU10x1
Matt white/ Matt black

IP 20

 Surface mounted type
Aluminium Body

VIVA-S2

1350.-

DIA 250x75 mm. H: 120 mm.

 GU10x2
Matt white/ Matt black

IP 20

 Surface mounted type
Aluminium Body



VIVA-S3

1850.-

DIA 450x75 mm. H: 120 mm.

 GU10x3
Matt white/ Matt black

IP 20

 Surface mounted type
Aluminium Body

TRACK LIGHT



RAZOR-M

1500.-

DIA 75 mm. H 130 mm.



LED COB 20W 1440lm



3000K, 4000K, 6000K
Matt white/ Matt black

IP 20

- Surface mounted type
- Aluminium Body
- Driver included
- Non-Dim

RAZOR-L

2000.-

DIA 90 mm. H 130 mm.



LED COB 30W 2400lm



3000K, 4000K, 6000K
Matt white/ Matt black

IP 20

- Surface mounted type
- Aluminium Body
- Driver included
- Non-Dim



TRACK LIGHT

RECESSED MAGNETIC TRACK

Aluminium 1phase 2wires magnetic track

1m.	Size : 33x50x1000 mm.	1250.-
1.5m.	Size : 33x50x1500 mm.	1875.-
2m.	Size : 33x50x2000 mm.	2500.-

● Color : Black



MAGNETIC TRACK CONNECTOR

1phase 2wires track light connector

I-Shape Connector	300.-
L-Shape Connector.	1000.-
Power cord	300.-

● Color : Black

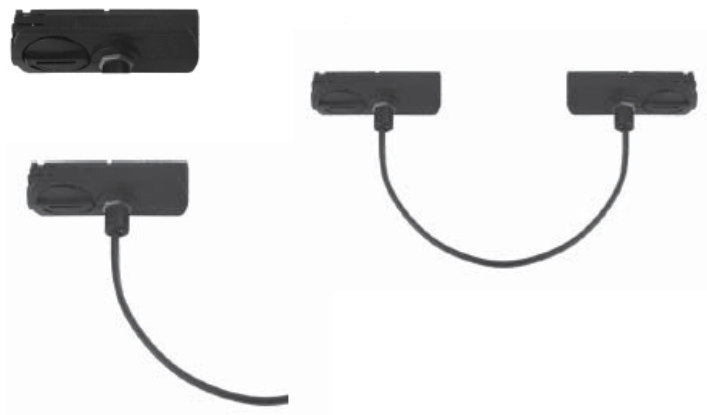
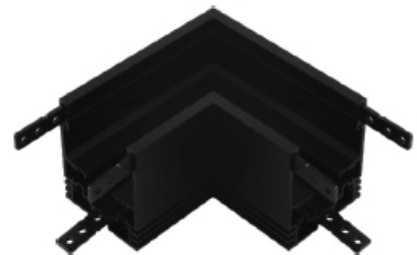

TRACK LIGHT



MESA-S

1650.-

DIA 37x135 mm. H 60 mm.



LED COB 6x1.5W 900lm

3000K, 4000K
Matt black

IP 20



Fixed
Aluminium Body
Driver included
Non-Dim
Use with Magnetic track only

MESA-M

2950.-

DIA 37x270 mm. H 60 mm.



LED COB 12x1.5W 1800lm

3000K, 4000K
Matt black

IP 20



Fixed
Aluminium Body
Driver included
Non-Dim
Use with Magnetic track only



MESA-L

3500.-

DIA 37x405 mm. H 60 mm.



LED COB 18x1.5W 2700lm

3000K, 4000K
Matt black

IP 20



Fixed
Aluminium Body
Driver included
Non-Dim
Use with Magnetic track only



TRACK LIGHT



MEENA-S

1650.-

DIA 24x300 mm. H 40 mm.



LED SMD 10W 800lm
3000K, 4000K
Matt black

IP 20



Fixed
Aluminium Body
Driver included
Non-Dim
Use with Magnetic track only

MEENA-M

2950.-

DIA 24x600 mm. H 40 mm.



LED SMD 20W 1600lm
3000K, 4000K
Matt black

IP 20



Fixed
Aluminium Body
Driver included
Non-Dim
Use with Magnetic track only

MEENA-L

3500.-

DIA 24x900 mm. H 40 mm.



LED SMD 30W 2400lm
3000K, 4000K
Matt black

IP 20



Fixed
Aluminium Body
Driver included
Non-Dim
Use with Magnetic track only

TRACK LIGHT



JUNE-S

2000.-

DIA 37x135 mm. H 60 mm.



LED COB 5x2W 800lm

3000K, 4000K
Matt black

IP 20

- Adjustable 1 side
- Aluminium Body
- Driver included
- Non-Dim
- Use with Magnetic track only

JUNE-M

3000.-

DIA 37x270 mm. H 60 mm.



LED COB 10x2W 1600lm

3000K, 4000K
Matt black

IP 20

- Adjustable 1 side
- Aluminium Body
- Driver included
- Non-Dim
- Use with Magnetic track only



JUNE-L

4000.-

DIA 37x405 mm. H 60 mm.



LED COB 15x2W 2400lm

3000K, 4000K
Matt black

IP 20

- Adjustable 1 side
- Aluminium Body
- Driver included
- Non-Dim
- Use with Magnetic track only



TRACK LIGHT



SEPT-GU10

1200.-

DIA 55 mm. H 100 mm.

 GU10x1
Matt black

IP 20

 Aluminium Body
Use with Magnetic track only

SEPT-S

1500.-

DIA 40 mm. H 80 mm.

 **LED COB 3W 235lm**
 3000K, 4000K
Matt black

IP 20

 Aluminium Body
Driver included
Non-Dim
Use with Magnetic track only



SEPT-M

2250.-

DIA 50 mm. H 108 mm.

 **LED COB 12W 924lm**
 3000K, 4000K
Matt black

IP 20

 Aluminium Body
Driver included
Non-Dim
Use with Magnetic track only

TRACK LIGHT



TULA-S

2000.-

DIA 25x112 mm. H 135 mm.



LED COB 6x2W 1100lm

3000K, 4000K
Matt black

IP 20

- Adjustable 2 sides
- Aluminium Body
- Driver included
- Non-Dim
- Use with Magnetic track only

TULA-M

3000.-

DIA 25x230 mm. H 135 mm.



LED COB 12x2W 2150lm

3000K, 4000K
Matt black

IP 20

- Adjustable 2 sides
- Aluminium Body
- Driver included
- Non-Dim
- Use with Magnetic track only



TRACK LIGHT



ADEN-S

2000.-

DIA 37x135 mm. H 60 mm.



LED COB 5x2W 800lm

3000K, 4000K
Matt black

IP 20

- Surface mounted type
Adjustable 1 side
Aluminium Body
Driver included
Non-Dim

ADEN-M

3000.-

DIA 37x270 mm. H 60 mm.



LED COB 10x2W 1600lm

3000K, 4000K
Matt black

IP 20

- Surface mounted type
Adjustable 1 side
Aluminium Body
Driver included
Non-Dim



ADEN-L

4000.-

DIA 37x405 mm. H 60 mm.



LED COB 15x2W 2400lm

3000K, 4000K
Matt black

IP 20

- Surface mounted type
Adjustable 1 side
Aluminium Body
Driver included
Non-Dim

TRACK LIGHT

1-PHASE TRACK

Aluminium 1phase 2wires track

1m.	Size : 33x20x1000 mm.	350.-
1.5m.	Size : 33x20x1500 mm.	525.-
2m.	Size : 33x20x2000 mm.	700.-

● Color : White/ Black



TRACK CONNECTOR

1phase 2wires track light connector

I-Shape Connector	100.-
L-Shape Connector.	150.-
T-Shape Connector	150.-
Power feed+End feed	180.-

● Color : White/ Black



TRACK LIGHT



1-PHASE RECESSED TRACK

1phase 2wires aluminium recessed track

1m. Size : 59.7x20.7x1000 mm. **500.-**

1.5m. Size : 59.7x20.7x1500 mm. **750.-**

2m. Size : 59.7x20.7x2000 mm. **1000.-**

● Color : White/ Black

TRACK CONNECTOR

1phase 2wires recessed track light connector

I-Shape Connector **200.-**

L-Shape Connector. **200.-**

Power feed+End feed **300.-**

● Color : White/ Black



TRACK LIGHT



3-PHASE TRACK

3 phase 4wires aluminium track

1m. Size : 32x33x1000 mm. **1150.-**

1.5m. Size : 32x33x1500 mm. **1750.-**

2m. Size : 32x33x2000 mm. **2250.-**

● Color : White/ Black

TRACK CONNECTOR

3phase 4wires recessed track light connector

I-Shape Connector **350.-**

L-Shape Connector. **350.-**

Power feed+End feed **350.-**

● Color : White/ Black

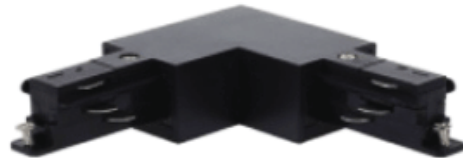

A 5x4 grid of squares. The top row is the lightest blue, and the bottom row is the darkest blue. The text 'DISPLAY LIGHT' is written in white, bold, italicized font in the bottom row.

DISPLAY LIGHT



SHOT

750.-

DIA 25 mm. H 52 mm.



LED COB 3W 270lm

3000K, 6000K

Matt black/ Matt silver

IP 20



Fully adjustable

Aluminium Body

Driver included

Non-Dim

Dimmable (0-10V/ Triac) Optional

PAX

850.-

DIA 58 mm. H 14 mm.



LED COB 3W 280lm



3000K

Matt black/ Matt silver

IP 44



Fixed

Aluminium Body

Driver included

Non-Dim



DISPLAY LIGHT



LEMO

1500.-

DIA 6 mm. H 250-350 mm.



LED SMD 3W 250lm



3000K, 6000K

Matt black/ Matt silver

IP 20



Fixed
Aluminium Body
Driver included
Non-Dim

TRIPO

135 0.-

DIA 10 mm. H 255 mm.



LED COB 3x1W 250lm



3000K, 6000K

Matt black/ Matt silver

IP 20



Fully adjustable
Aluminium Body
Driver included
Non-Dim



MINI SPOT

800.-

DIA 22 mm. H 46 mm.



LED COB 3x1W 80lm



3000K, 6000K

Matt black/ Matt silver

IP 20



Fully adjustable
Aluminium Body
Use with 12Vdc power supply
Use with mini track (600B/m.)
Non-Dim



DISPLAY LIGHT



NAKO

1150.-

DIA 23x33 mm. H 310 mm.



LED COB 3W 270lm



3000K, 4000K, 6000K
Matt black/ Matt silver

IP 20

- Fully adjustable
- Aluminium Body
- Driver included
- Non-Dim
- Dimmable (0-10V/ Triac) Optional

HAPER

1350.-

DIA 80x25x10 mm. H 320 mm.



LED COB 3x1W 270lm



6000K
Matt black/ Matt silver

IP 20

- Fully adjustable
- Aluminium Body
- Driver included
- Non-Dim
- Dimmable (0-10V/ Triac) Optional



DISPLAY LIGHT



BELLA

1800.-

DIA 24 mm. H 198 mm.



LED COB 3x1W 270lm



6000K

Matt black/ Matt silver

IP 20

- Fully adjustable
- Aluminium Body
- Driver included
- Non-Dim
- Dimmable (0-10V/ Triac) Optional

SOLO

1650.-

DIA 15x43 mm. H 300 mm.



LED COB 3W 270lm



6000K

Matt black/ Matt silver

IP 20

- Fully adjustable
- Aluminium Body
- Driver included
- Non-Dim
- Dimmable (0-10V/ Triac) Optional



DISPLAY LIGHT



JANELL

1550.-

DIA 23x33 mm. H 300 mm.



LED COB 3W 270lm

3000K, 4000K, 6000K
Matt black/ Matt silver

IP 20



Fully adjustable
Aluminium Body
Driver included
Non-Dim
Dimmable (0-10V/ Triac) Optional

FREYA

1450.-

DIA 18x58 mm. H 338 mm.



LED COB 3x1W 270lm

3000K, 4000K, 6000K
Matt black/ Matt silver

IP 20



Fully adjustable
Aluminium Body
Driver included
Non-Dim
Dimmable (0-10V/ Triac) Optional



DISPLAY LIGHT



EMMY-S

1500.-

DIA 15x55 mm. H 200 mm.



LED COB 2W 160lm

3000K, 4000K, 6000K
Matt black/ Matt silver

IP 20



Fully adjustable
Aluminium Body
Driver included
Non-Dim
Dimmable (0-10V/ Triac) Optional

EMMY-M

2000.-

DIA 15x55 mm. H 200 mm.



LED COB 2x2W 320lm

3000K, 4000K, 6000K
Matt black/ Matt silver

IP 20



Fully adjustable
Aluminium Body
Driver included
Non-Dim
Dimmable (0-10V/ Triac) Optional



DISPLAY LIGHT



ZOOM

2000.-

DIA 30x50 mm. H 200 mm.



LED COB 2W 160lm

15-36° 3000K, 4000K, 6000K
Matt black/ Matt silver

IP 20



Fully adjustable
Aluminium Body
Driver included
Non-Dim
Dimmable (0-10V/ Triac) Optional

ROLL

1800.-

DIA 15x55 mm. H 200 mm.



LED COB 2W 160lm

24° 3000K, 4000K, 6000K
Matt black/ Matt silver

IP 20



Fully adjustable
Aluminium Body
Driver included
Non-Dim
Dimmable (0-10V/ Triac) Optional



DISPLAY LIGHT

SAPP

4000.-

DIA 16x18 mm. H 1000 mm.



LED COB 7x1W 560lm

3000K, 4000K, 6000K
Matt black/ Matt silver

IP 20



Fully adjustable
Aluminium Body

Driver included

Non-Dim

Dimmable (0-10V/ Triac) Optional

SAMO

1800.-

DIA 12.5 mm. H 336 mm.



LED SMD 5W 500lm

3000K, 4000K, 6000K
Matt black/ Matt silver

IP 20



Adjustable

Aluminium Body

12Vdc Driver excluded

Non-Dim



DISPLAY LIGHT



DOSS 1.5W

600.-

DIA 35 mm. H 22 mm.



LED COB 1.5W 140lm



3000K, 4000K

Matt white, Matt black trim



Fixed

Aluminium Body

Driver included

Non-Dim

Dimmable (0-10V/ Triac) Optional

IP 20

RIZ 3W

750.-

DIA 40 mm. H 50 mm.



CREE CHIP LED 3W 260lm



3000K, 4000K

Matt white, Matt black trim



Fixed

Aluminium Body

Driver included

Non-Dim

Dimmable (0-10V/ Triac) Optional

IP 20



FOCUS 3W

850.-

DIA 48 mm. H 37 mm.



CREE CHIP LED 3W 260lm



3000K, 6000K

Matt white, Matt black trim



Fully adjustable

Aluminium Body

Driver included

Non-Dim

Dimmable (0-10V/ Triac) Optional

IP 20

DISPLAY LIGHT





MINI 3W

750.-

DIA 52 mm. H 25 mm.



CREE CHIP LED 3W 260lm



3000K, 4000K, 6000K

Matt white/ Matt black/ Silver



Adjustable

Aluminium Body

Driver included

Non-Dim

Dimmable (0-10V/ Triac) Optional

IP 20

MINI-D 3W

1000.-

DIA 52 mm. H 35 mm.



LED COB 3W 260lm



3000K, 4000K

Sand white/ Sand black trim



Adjustable

Aluminium Body

Driver included

Non-Dim

Dimmable (0-10V/ Triac) Optional

IP 20

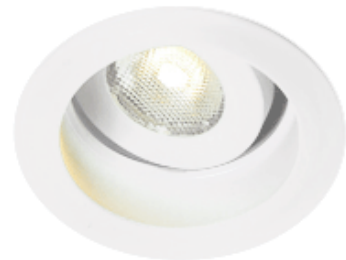

DISPLAY LIGHT



DOSS 1.5W

600.-

DIA 35 mm. H 22 mm.



LED COB 1.5W 140lm



3000K, 4000K

Matt white, Matt black trim



Fixed

Aluminium Body

Driver included

Non-Dim

Dimmable (0-10V/ Triac) Optional

IP 20

RIZ 3W

750.-

DIA 40 mm. H 50 mm.



CREE CHIP LED 3W 260lm



3000K, 4000K

Matt white, Matt black trim



Fixed

Aluminium Body

Driver included

Non-Dim

Dimmable (0-10V/ Triac) Optional

IP 20



FOCUS 3W

850.-

DIA 48 mm. H 37 mm.



CREE CHIP LED 3W 260lm



3000K, 6000K

Matt white, Matt black trim



Fully adjustable

Aluminium Body

Driver included

Non-Dim

Dimmable (0-10V/ Triac) Optional

IP 20

DISPLAY LIGHT





JOOX-A 3W

750.-

DIA 50 mm. H 30 mm.



CREE CHIP LED 3W 265lm



3000K, 4000K
Matt white trim

IP 20



Adjustable
Aluminium Body
Driver included
Non-Dim
Dimmable (0-10V/ Triac) Optional

JOOX-B 3W

750.-

DIA 40 mm. H 28 mm.



CREE CHIP LED 3W 265lm



3000K, 4000K
Matt white trim

IP 20



Fixed
Aluminium Body
Driver included
Non-Dim
Dimmable (0-10V/ Triac) Optional



DISPLAY LIGHT

A 5x4 grid of squares. The top row consists of four squares with a gradient from light blue to white. The second row consists of four squares with a gradient from light blue to light grey. The third row consists of four squares with a gradient from medium blue to light blue. The fourth row consists of four squares with a gradient from dark blue to medium blue. The bottom row consists of four squares with a gradient from dark blue to medium blue. The text 'BED SIDE LAMP' is written in white, bold, italicized capital letters across the bottom row.

BED SIDE LAMP



GIMBAL

3000.-

DIA 110 mm. D 60 mm.



LED COB 3W 120lm



3000K

Matt black/ Matt white

IP 20

- 350 Degree rotatable
- Recessed type
- Built-in Switch on-off
- Aluminium Body
- Driver included
- Non-Dim

LEDTUBE

3500.-

Head 30x110 mm. Base 75x180 mm.



LED COB 3W 120lm



3000K

Matt black/ Chrome

IP 20

- Recessed type
- Built-in Switch on-off
- Aluminium Body
- Driver included
- Non-Dim



BED SIDE LAMP

GOOSS-S

2350.-

Head 25x80 mm. Base D90x60x30 mm.



LED COB 3W 120lm



3000K

Matt black/ Matt white

IP 20

- Surface type
- Built-in Switch on-off
- Aluminium Body
- Driver included
- Non-Dim

READY-S

1200.-

Head 19x77 mm. Base 64xH29 mm.



LED COB 3W 120lm



3000K

Matt black/ Matt white

IP 20

- Surface type
- Built-in Switch on-off
- Aluminium Body
- Driver included
- Non-Dim



FLEXTOR

3000.-

Head 28x68 mm. Base 110x110 mm.



LED COB 3x1W 120lm



3000K

Matt black

IP 20



- Recessed type
- Built-in Switch on-off
- Aluminium Body
- Driver included
- Non-Dim

LAVI

3000.-

Head 28x80 mm. Base 110x60 mm.



LED COB 3W 120lm



3000K

Matt black

IP 20

- Recessed type
- Built-in Switch on-off
- Aluminium Body
- Driver included
- Non-Dim



LEDSTAR

2750.-

Head 29x110 mm. Base 90xH30 mm.



LED COB 3W 270lm

3000K
Matt black/

IP 20

- Surface type
- Built-in Switch on-off
- Aluminium Body
- Driver included
- Non-Dim



BIRDY

2350.-

Head 25x100 mm Base 80x80xH25 mm.



LED COB 3W 120lm

3000K
Matt black

IP 20

- Surface type
- Built-in Switch on-off
- Aluminium Body
- Driver included
- Non-Dim



BED SIDE LAMP



ANNY

3500.-

Head 35x60 mm. Base 60 mm.



LED COB 3W 120lm



3000K

Matt black/ Matt white

IP 20



Surface type

Built-in Switch on-off

Aluminium Body

Driver included

Non-Dim

VISTA

1800.-

Head 45x120 mm. Base 39x150xH39 mm.



LED COB 3W 120lm



3000K

Matt black/ Matt white

IP 20



Surface type

Built-in Switch on-off

Aluminium Body

Driver included

Non-Dim



VENO

3000.-

Head 30x100 mm. Base 59x172x35 mm.



LED COB 3W 120lm



3000K

Matt black/ Matt white

IP 20



Recessed type

Built-in Switch on-off

Aluminium Body

Driver included

Non-Dim

BED SIDE LAMP





LEDDOCK

3500.-

DIA 41x200 mm. H 45 mm.



LED COB 3W 120lm

3000K

Matt black/ Chrome

IP 20

- Surface type
- Built-in Switch on-off
- Aluminium Body
- Driver included
- Non-Dim

LEDPOP

4250.-

DIA 80x210 mm. H 72.5 mm.



LED COB 3W 120lm

3000K

Matt black/ Chrome

IP 20

- Recessed type
- Built-in Switch on-off
- Aluminium Body
- Driver included
- Non-Dim



BED SIDE LAMP



LEDDY

2350.-

Head 29x110 mm. Base 81xH36 mm.



LED COB 3W 120lm

3000K



Matt black/ Matt white

IP 20



Surface type

Built-in Switch on-off

Aluminium Body

Driver included

Non-Dim

Surface

LEDCAN

3000.-

Head 60x95 mm. Base 90xH23 mm.



GU10x1

Matt white/ Matt black

IP 20



Surface type

Built-in Switch on-off

Aluminium Body

Driver included

Non-Dim



BED SIDE LAMP



DIPO

4000.-

Head 29x110 mm. Base 140x240 mm.



LED COB 3W + 3W 120lm



3000K

Matt black/ Matt white

IP 20

- Recessed type
- Built-in Switch on-off
- Aluminium Body
- Driver included
- Non-Dim

LEMON

4000.-

Head 29x110 mm. Base 170x81x40 mm.



LED COB 3W + 3W 120lm



3000K

Matt black/ Matt white

IP 20

- Surface type
- Built-in Switch on-off
- Aluminium Body
- Driver included
- Non-Dim



PABLO

1800.-



LED COB 3W 180lm

3000K

30°

Matt black/ Matt white

IP 20

- Recessed type
- Built-in Switch on-off
- Aluminium Body
- Driver included
- Non-Dim

COLT

1800.-

Head 30x100 mm. Base 86x86x25 mm.



LED COB 3W 180lm

3000K

30°

Matt black/ Matt white

IP 20

- Surface type
- Built-in Switch on-off
- Aluminium Body
- Driver included
- Non-Dim



BED SIDE LAMP

LAZO

3500.-

Head 24x84 mm. Base 53x160x50 mm.



LED COB 3W 120lm

3000K

30°

Matt black/ Matt white

IP 20

- Surface type
- Built-in Switch on-off
- Aluminium Body
- Driver included
- Non-Dim



LUSI

4000.-

Head 29x110 mm. Base 80x160x35 mm.



LED COB 3W 120lm

30°

3000K

Matt black/ Matt white

IP 20

- Surface type
- Built-in Switch on-off
- Aluminium Body
- Driver included
- Non-Dim



BED SIDE LAMP



TARGA

4000.-

Head 28x68 mm. Base 210x120x128 mm.



LED COB 3W 120lm



3000K

Matt black/ Matt white

IP 20

- Surface type
- Built-in Switch on-off
- Aluminium Body
- Driver included
- Non-Dim
- 2xUSB charger 5V 1A

LEDTO

3000.-

Head 43x80 mm. Base 70x7 mm.



LED COB 5W 430lm



3000K

Matt black/ Matt white

IP 20

- Surface type
- Built-in Switch on-off
- Aluminium Body
- Driver included
- Non-Dim

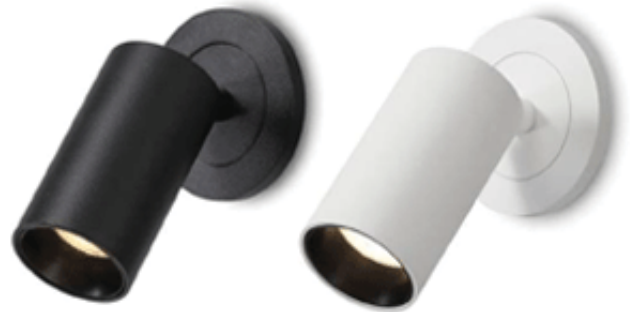

A 5x4 grid of squares. The top row is white, and the bottom row is dark blue. The colors transition from white at the top to dark blue at the bottom, with intermediate shades of light blue, medium blue, and teal. The text 'WALL LIGHT' is located in the bottom right corner of the grid.

WALL LIGHT



CUBE-1

1800.-

DIA 60x60 mm. H 70 mm.



LED COB 1W 70lm

3000K

Matt white/ Matt black



IP 20

- Aluminium body
- Driver included
- Non-Dim

CUBE-2

2000.-

DIA 60x60 mm. H 100 mm.



LED COB 2x1W 140lm

3000K

Matt white/ Matt black



IP 20

- Aluminium body
- Driver included
- Non-Dim



WALL LIGHT



COZY

1500.-

DIA 89x90 mm. D 32 mm.



LED COB 2x1W 140lm



3000K

Sand white/ Sand black

IP 20

- Aluminium body
- Driver included
- Non-Dim

LALA

2000.-

DIA 100x200 mm. D 80 mm.



LED COB 10W 590lm



3000K

Sand white/ Sand black

IP 20

- Aluminium body
- Driver included
- Non-Dim



PURE

3200.-

DIA 17x27 mm. L 400 mm.



LED COB 5W 500lm



3000K

Matt white/ Matt black

IP 20

- Aluminium body
- Driver included
- Non-Dim

• WALL LIGHT



FLAT-1

2000.-

DIA 100x100 mm. H 35 mm.



LED COB 3W 120lm



3000K

Matt white/ Matt black



Aluminium body
Driver included
Non-Dim

FLAT-2

2500.-

DIA 100x110 mm. H 35 mm.



LED COB 2x3W 240lm



3000K

Matt white/ Matt black



Aluminium body
Driver included
Non-Dim





WALL LIGHT



BOXX-L

1350.-

DIA 60x90 mm. H 170 mm.

 GU10x2
 Sand white/ Sand black

IP 20

 Aluminium body

HOVER-S

1200.-

DIA 83x100 mm. H 102 mm.

 G9x1
 Sand white/ Sand black

IP 20

 Aluminium body



WALL LIGHT



LINER

2750.-

DIA 70x250 mm. D 80 mm.



LED SMD 2x4W 800lm



3000K

Matt white/ Matt black

IP 20

- Aluminium body
- Driver included
- Non-Dim

LAVA

8000.-

DIA 140 mm. D 316 mm.



LED COB 12W 1200lm



3000K

Matt silver/ Matt black

IP 20

- Aluminium body
- Driver included
- Non-Dim



JINO

6000.-

DIA 148 mm. L 127 mm.



LED COB 6W 600lm



3000K

Matt white/ Matt black

IP 20

- Aluminium body
- Driver included
- Non-Dim

• WALL LIGHT



HEXTA-1

1800.-

DIA 110 mm. H 120 mm.

 GU10x1
Sand white/ Sand black

IP 20

 Aluminium body

HEXTA-2

2800.-

DIA 110 mm. H 220 mm.

 GU10x2
Sand white/ Sand black

IP 20

 Aluminium body



WALL LIGHT



COLON-R1

1500.-

DIA 60 mm. H 110 mm.

 GU10x1
Sand white/ Sand black

IP 20

 Aluminium body

COLON-R2

2350.-

DIA 60 mm. H 190 mm.

 GU10x2
Sand white/ Sand black

IP 20

 Aluminium body



WALL LIGHT



SUMMER-R1

4000.-

DIA 150 mm. D 160 mm.



LED COB 3W 230lm



3000K

Matt white/ Matt black



Aluminium body
Driver included
Non-Dim

SUMMER-R2

4500.-

DIA 150 mm. D 160 mm.



LED COB 2x3W 460lm



3000K

Matt white/ Matt black



Aluminium body
Driver included
Non-Dim



WALL LIGHT



SOFT

3500.-

DIA 162 mm. D 55 mm.



LED SMD 4W 1m



3000K

Matt white/ Matt black

IP 20

- Aluminium body
- Driver included
- Non-Dim

RING

3000.-

DIA 139 mm. H 180 mm.



LED SMD 6W 360lm



3000K

Matt silver/ Matt black

IP 20

- Aluminium body
- Driver included
- Non-Dim



PIVOT

4000.-

DIA 60 mm. L 410 mm.



LED COB 12W 380lm



3000K

Matt white/ Matt black

IP 20

- Aluminium body
- Driver included
- Non-Dim

• WALL LIGHT

A 5x4 grid of squares. The top row is white, the second row is light blue, the third row is medium blue, the fourth row is dark blue, and the bottom row is the darkest blue. The text 'STEP LIGHT' is written in white, bold, italicized capital letters in the bottom right corner of the grid.

STEP LIGHT



STEP-A

1000.-

DIA 70x70 mm. H 18.6 mm.



LED COB 1.5W 90lm



3000K

Matt white

IP 20

- Recessed type
- Aluminium cover
- Driver included
- Non-Dim

STEP-B

1150.-

DIA 70x110 mm. H 25.6 mm.



LED COB 3.5W 168lm



3000K

Matt white

IP 20

- Recessed type
- Aluminium cover
- Driver included
- Non-Dim



STEP-C

900.-

DIA 80x80 mm. H 32 mm.



LED COB 1W 80lm



3000K

Matt white

IP 20

- Recessed type
- Aluminium cover
- Driver included
- Non-Dim

STEP LIGHT



STEP-D

1500.-

DIA 86 mm. H 38 mm.



LED COB 3W 190lm



3000K

Matt white/ Matt black

IP 54

- Recessed type
- Aluminium cover
- Driver included
- Non-Dim

STEP-E

1500.-

DIA 87x87 mm. H 38 mm.



LED COB 3W 190lm



3000K

Matt white/ Matt black

IP 54

- Recessed type
- Aluminium cover
- Driver included
- Non-Dim



STEP-F

1500.-

DIA 87x87 mm. H 55 mm.



LED COB 3W 190lm



3000K

Matt white/ Matt black

IP 54

- Recessed type
- Aluminium cover
- Driver included
- Non-Dim

STEP LIGHT



STEP-G

1500.-

DIA 87x87 mm. H 55 mm.



LED COB 3W 190lm

120° 3000K
Matt white

IP 54

- Recessed type
Aluminium cover
Driver included
Non-Dim

STEP-H

800.-

DIA 65x65 mm. H 43 mm.



LED COB 3W 145lm

120° 3000K
Matt white

IP 20

- Recessed type
Aluminium cover
Driver included
Non-Dim



STEP-L

1000.-

DIA 75x165 mm. H 43 mm.



LED COB 5W 3550lm

120° 3000K
Matt white

IP 20

- Recessed type
Aluminium cover
Driver included
Non-Dim

STEP LIGHT



CLOUDY-R

1800.-

DIA: 48 mm. H: 30 mm.



LED COB 1W 80lm



3000K

Milky acrylic cover

IP 20

- Recessed type
- Acrylic cover
- Driver included
- Non-Dim

SHADOW-R

1800.-

DIA 48 mm. H 33 mm.



LED COB 1W 80lm



3000K

Matt white cover

IP 20

- Recessed type
- Aluminium cover
- Driver included
- Non-Dim



STEP LIGHT

A 4x4 grid of squares. The top row is white, the second row is light blue, the third row is medium blue, and the bottom row is dark blue. The text 'FLUORESCENT LIGHT' is written in white, bold, italicized capital letters in the bottom right corner of the grid.

***FLUORESCENT
LIGHT***

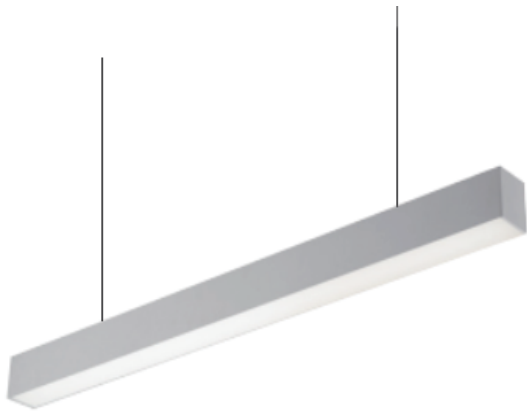

OFFO-P

3000.-

DIA 55x85 mm. L 1250 mm.



LED T8x1

Matt white, Matt silver, Matt black

IP 20



Aluminium body

Acrylic diffuser

1.5m. Sling

OFFO-2P

5600.-

DIA 85x140 mm. L 1250 mm.



LED T8x2

Matt white, Matt silver, Matt black

IP 20



Aluminium body

Acrylic diffuser

1.5m. Sling

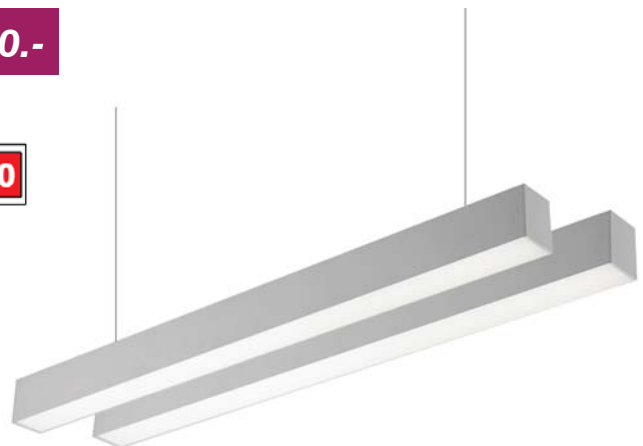

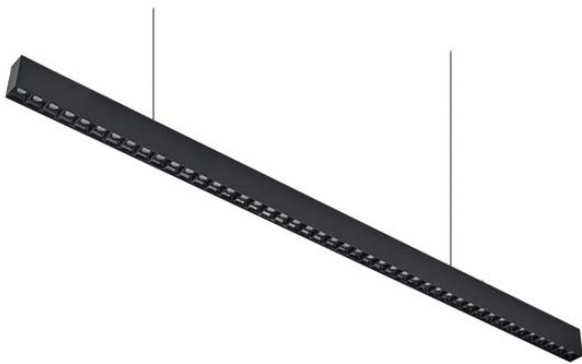

BLADE-A

4500.-

DIA 33x60 mm. L 1200 mm.



LED 40W 3200lm



3000K, 4000K

Matt white/ Matt black

IP 20



Aluminium body
1.5m. Sling

BLADE-B

4500.-

DIA 33x60 mm. L 1200 mm.



LED 40W 3200lm



4000K, 6500K

Matt white/ Matt black

IP 20



Aluminium body
Acrylic diffuser
1.5m. Sling

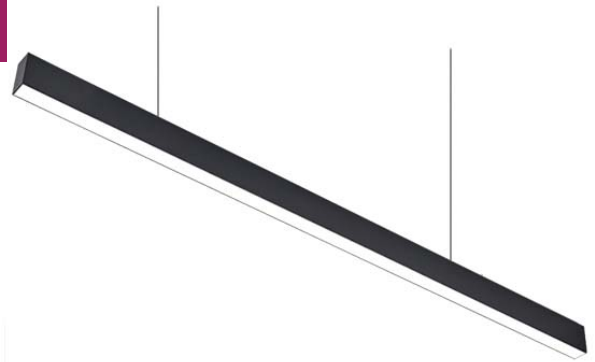

BLADE-C

4500.-

DIA 33x60 mm. L 1200 mm.



LED 20W + 20W 3200lm



4000K

Matt white/ Matt black

IP 20



Aluminium body
Acrylic diffuser
1.5m. Sling

FLUORESCENT LIGHT

TUBE

3600.-

DIA 60 mm. L 1220 mm.



LED T8x1



Matt silver end cap

IP 20



Aluminium body

Acrylic diffuser

2m. Sling

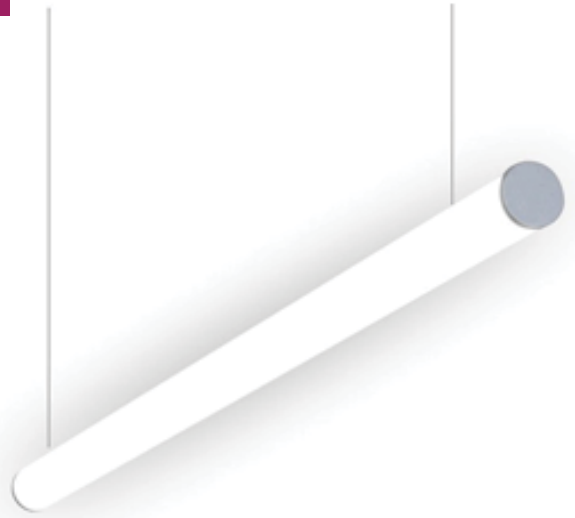

JELLY

2500.-

DIA 22x53 mm. L 1200 mm.



LED 30W 2400lm



4000K, 6500K

Matt black

IP 20



PC body

Acrylic diffuser

1.5m. Sling





NORD

6500.-

DIA 45x45 mm. L 1000 mm.



LED SMD 40W 2950lm



4000K

Matt black

IP 20



Aluminium body

1.5m. Sling

Accessories : Honeycomb, Frosted glass

Clear glass

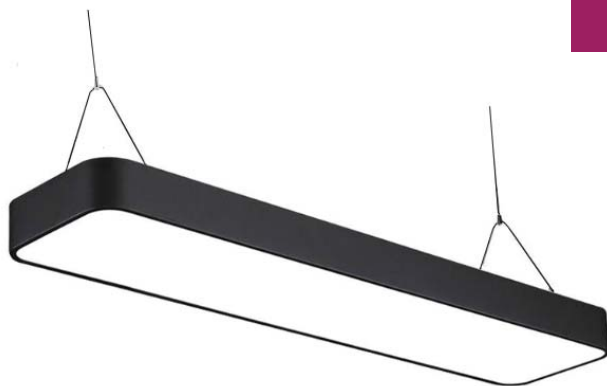

RECTA

3000.-

DIA 200x1200 mm. H 60 mm.



LED SMD 48W 3600lm



4000K, 6500K

Matt black trim

IP 20



Metal body

Acrylic diffuser

1.5m. Sling

FLUORESCENT LIGHT



OFFO-RPC

3000.-

DIA 90x85 mm. L 1257 mm.

 LED T8x1
Matt white trim

IP 20

 Aluminium body
Acrylic diffuser

OFFO-SPC

3000.-

DIA 55x85 mm. L 1250 mm.

 LED T8x1
Matt white, Matt silver, Matt black

IP 20

 Aluminium body
Acrylic diffuser





OFFO-RLV

3200.-

DIA 90x85 mm. L 1257 mm.

 LED T8x1
Matt white trim

IP 20

 Aluminium body
Mirror anodized aluminum louver

OFFO-SLV

3200.-

DIA 68x90 mm. L 1245 mm.

 LED T8x1
Matt silver

IP 20

 Aluminium body
Mirror anodized aluminum louver





NEO-RPC

Recessed acrylic diffuser luminaire

- T8 2x18W Size : 30x60 cm.
- T8 2x18W Size : 60x60 cm.
- T8 3x18W Size : 60x60 cm.
- T8 4x18W Size : 60x60 cm.
- T8 2x36W Size : 30x120 cm.
- T8 2x36W Size : 60x120 cm.
- T8 3x36W Size : 60x120 cm.
- T8 4x36W Size : 60x120 cm.

NEO-SPC

Surface mounted acrylic diffuser luminaire

- T8 2x18W Size : 30x60 cm.
- T8 2x18W Size : 60x60 cm.
- T8 3x18W Size : 60x60 cm.
- T8 4x18W Size : 60x60 cm.
- T8 2x36W Size : 30x120 cm.
- T8 2x36W Size : 60x120 cm.
- T8 3x36W Size : 60x120 cm.
- T8 4x36W Size : 60x120 cm.





NEO-RLV

Recessed louver luminaire

- T8 2x18W Size : 30x60 cm.
- T8 2x18W Size : 60x60 cm.
- T8 3x18W Size : 60x60 cm.
- T8 4x18W Size : 60x60 cm.
- T8 2x36W Size : 30x120 cm.
- T8 2x36W Size : 60x120 cm.
- T8 3x36W Size : 60x120 cm.
- T8 4x36W Size : 60x120 cm.

NEO-SLV

Surface mounted louver luminaire

- T8 2x18W Size : 30x60 cm.
- T8 2x18W Size : 60x60 cm.
- T8 3x18W Size : 60x60 cm.
- T8 4x18W Size : 60x60 cm.
- T8 2x36W Size : 30x120 cm.
- T8 2x36W Size : 60x120 cm.
- T8 3x36W Size : 60x120 cm.
- T8 4x36W Size : 60x120 cm.





CURVE-1

Recessed indirect light luminaire

T8 2x18W Size : 60x60 cm.

T8 2x36W Size : 60x120 cm.

CURVE-2

Recessed indirect light luminaire

T8 2x18W Size : 60x60 cm.

T8 2x36W Size : 60x120 cm.





U-TYPE

U-type acrylic diffuser luminaire

- T8 1x18W Size : W70xH100xL636 mm.
- T8 2x18W Size : W210xH75xL636 mm.
- T8 1x36W Size : W70xH100xL1245 mm.
- T8 2x36W Size : W210xH75xL1245 mm.

WEATHER PROOF

Weather proof luminaire

- T8 1x18W Size : W110xH108xL670 mm.
- T8 2x18W Size : W170xH108xL670 mm.
- T8 1x36W Size : W110xH108xL1270 mm.
- T8 2x36W Size : W170xH108xL1270 mm.





CLEAN ROOM

Recessed clean room luminaire

- T8 2x18W Size : 30x60 cm.
- T8 2x18W Size : 60x60 cm.
- T8 3x18W Size : 60x60 cm.
- T8 4x18W Size : 60x60 cm.
- T8 2x36W Size : 30x120 cm.
- T8 2x36W Size : 60x120 cm.
- T8 3x36W Size : 60x120 cm.
- T8 4x36W Size : 60x120 cm.

CLEAN ROOM

Surface mounted clean room luminaire

- T8 2x18W Size : 30x60 cm.
- T8 2x18W Size : 60x60 cm.
- T8 3x18W Size : 60x60 cm.
- T8 4x18W Size : 60x60 cm.
- T8 2x36W Size : 30x120 cm.
- T8 2x36W Size : 60x120 cm.
- T8 3x36W Size : 60x120 cm.
- T8 4x36W Size : 60x120 cm.





COLD ROOM

Surface cold room luminaire

- T8 1x18W Size : W120xH115xL705 mm.
- T8 2x18W Size : W190xH115xL705 mm.
- T8 1x36W Size : W120xH115xL1315 mm.
- T8 2x36W Size : W190xH115xL1315 mm.

WIRE GUARD

Wire guard batten type luminaire

- T8 1x18W Size : W64xH112xL636 mm.
- T8 2x18W Size : W124xH112xL636 mm.
- T8 1x36W Size : W64xH112xL1245 mm.
- T8 2x36W Size : W124xH112xL1245 mm.





T5 SET

LED T5 SET 3000K, 4000K, 6500K

3.4W Size : 21x32xL325 mm.

6.5W Size : 21x32xL585 mm.

9W Size : 21x32xL885 mm.

13W Size : 21x32xL1185 mm.

T8 SET

LED T8 SET 3000K, 4000K, 6500K

T8 1x9W Size : 30x50xL615 mm.

T8 1x18W Size : 30x50xL1225 mm.





TAPER

Taper batten type luminaire

- T8 1x18W Size : W155xH115xL636 mm.
- T8 2x18W Size : W155xH90xL636 mm.
- T8 1x36W Size : W155xH115xL1245 mm.
- T8 2x36W Size : W155xH90xL1245 mm.

INDUSTRIAL

Industrial type luminaire

- T8 1x18W Size : W135xH101xL636 mm.
- T8 2x18W Size : W230xH101xL636 mm.
- T8 1x36W Size : W135xH101xL1245 mm.
- T8 2x36W Size : W230xH101xL1245 mm.



A 5x4 grid of squares. The top row is white, the second row is light blue, the third row is medium blue, the fourth row is dark blue, and the bottom row is the darkest blue. The text 'WALL LIGHT' is written in white, bold, italicized capital letters in the bottom right corner of the grid.

WALL LIGHT



YORK-R1

1150.-

DIA 90 mm. H 170 mm.



1x E27 MAX. LED 13W

IP 65



Black / Grey

Aluminium body

Clear glass cover

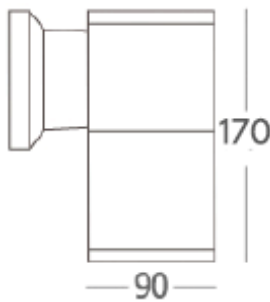

YORK-R2

1350.-

DIA 90 mm. H 280 mm.



2x E27 MAX. LED 13W

IP 65



Black / Grey

Aluminium body

Clear glass cover

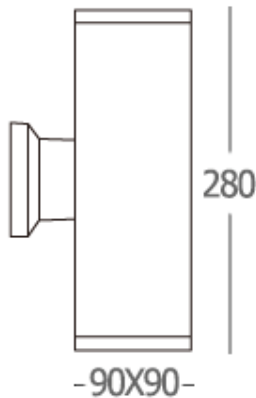

WALL LIGHT



YORK-S1

1150.-

DIA 90x90 mm. H 190 mm.



1x E27 MAX. LED 13W

IP 65

- ● Black / Grey
- Aluminium body
- Clear glass cover

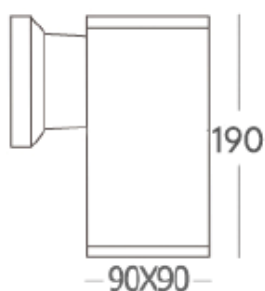

YORK-S2

1350.-

DIA 90x90 mm. H 280 mm.



2x E27 MAX. LED 13W

IP 65

- ● Black / Grey
- Aluminium body
- Clear glass cover

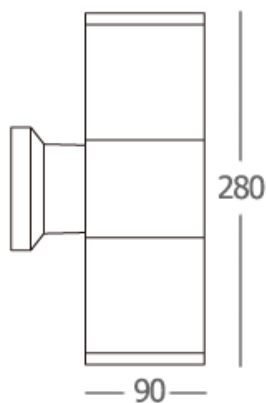

WALL LIGHT



ALYN-R1

1150.-

DIA 90 mm. H 133 mm.



1x GU10 MAX. 50W

IP 65

● ● Black / Grey

Aluminium body

Clear glass cover

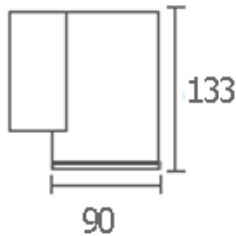

ALYN-R2

1350.-

DIA 90 mm. H 166 mm.



2x GU10 MAX. 50W

IP 65

● ● Black / Grey

Aluminium body

Clear glass cover

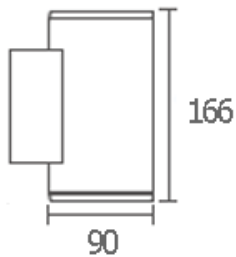

WALL LIGHT



ALYN-S1

1150.-

DIA 87x87 mm. H 130 mm.



1x GU10 MAX. 50W

IP 65

● ● Black / Grey

Aluminium body

Clear glass cover

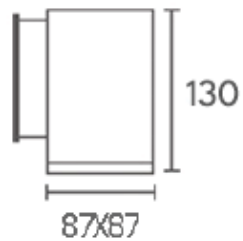

ALYN-S2

1350.-

DIA 87x87 mm. H 160 mm.



2x GU10 MAX. 50W

IP 65

● ● Black / Grey

Aluminium body

Clear glass cover

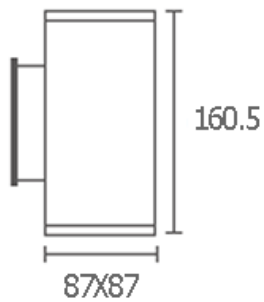

WALL LIGHT



WATT-S1

800.-

DIA 81x68 mm. D 92 mm.



1x GU10 MAX. 50W

IP 54

- ● Black / Grey
- Aluminium body
- Clear glass cover

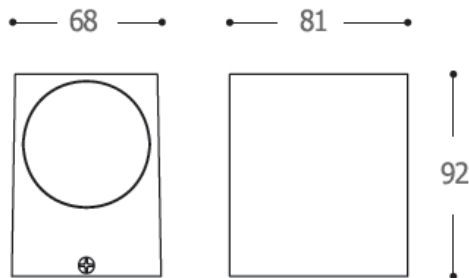

WATT-S2

1000.-

DIA 68x150 mm. D 92 mm.



2x GU10 MAX. 50W

IP 54

- ● Black / Grey
- Aluminium body
- Clear glass cover

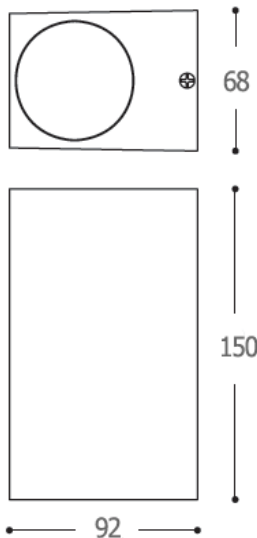

WALL LIGHT



WATT-R1

800.-

DIA 65x78 mm. D 95 mm.



1x GU10 MAX. 50W

IP 54

- ● Black / Grey
- Aluminium body
- Clear glass cover

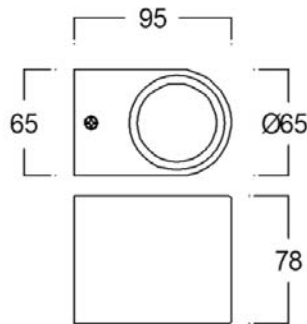

WATT-R2

1000.-

DIA 65x145 mm. D 95 mm.



2x GU10 MAX. 50W

IP 54

- ● Black / Grey
- Aluminium body
- Clear glass cover

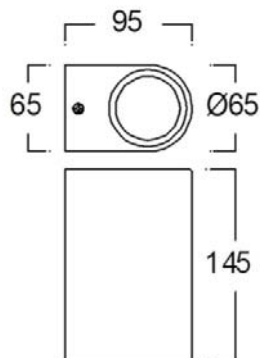

WALL LIGHT



FENIX-S1

1500.-

DIA 100x150 mm. D 100 mm.



1x GU10 MAX. 50W

IP 54



Black

Aluminium body

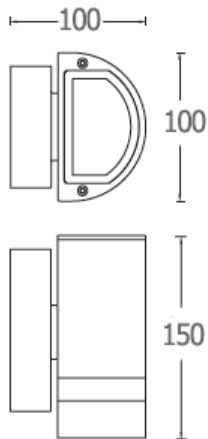

FENIX-S2

1800.-

DIA 100x230 mm. D 1000 mm.



2x GU10 MAX. 50W

IP 54



Black

Aluminium body

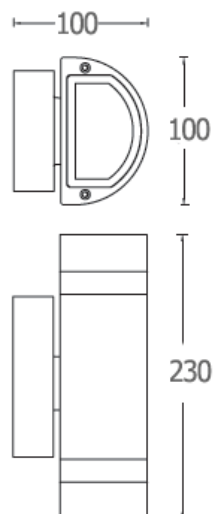

WALL LIGHT



MIND

1200.-

DIA 100 mm. H 90 mm.



1x GU10 MAX. 50W

IP 54



Black

Aluminium body

Clear glass cover

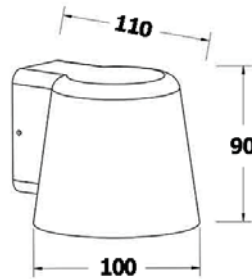

PACO

1000.-

DIA 95x65 mm. H 95 mm.



1x GU10 MAX. 50W

IP 54



Black

Aluminium body

Clear glass cover

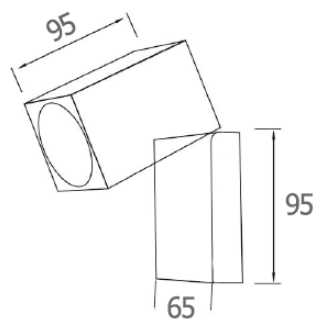

WALL LIGHT



MABEL-R2

2000.-

DIA 120x115 mm. D 90 mm.

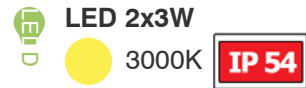

- Black
- LED Driver Included
- Aluminium body

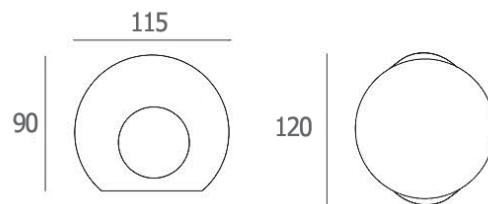

MABEL-R4

2250.-

DIA 120 mm. D 90 mm.

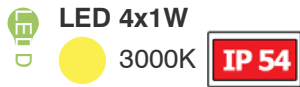

- Black
- LED Driver Included
- Aluminium body

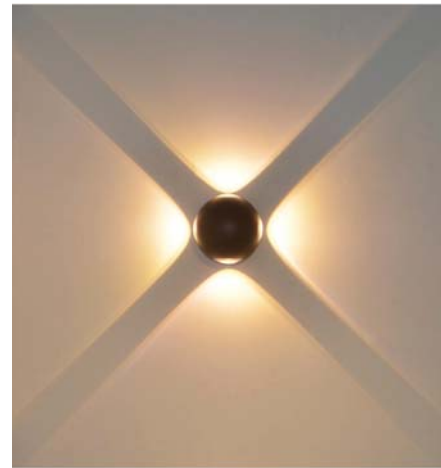
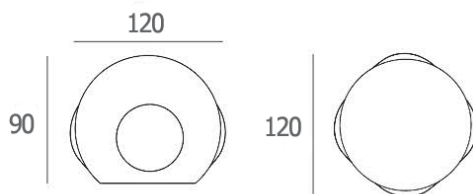

WALL LIGHT



SAGA

2500.-

DIA 109x173 mm. D 63 mm.



LED 2x3W 270lm



3000K

IP 54



Black / Grey

LED Driver Included

Aluminium body

Clear glass cover

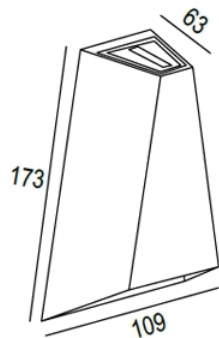

WEE

3000.-

DIA 44x125 mm. D 90 mm.



LED 2x3W 270lm



3000K

IP 54



Black

LED Driver Included

Aluminium body

Clear glass cover

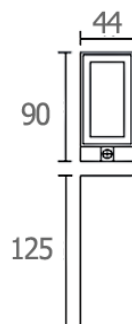

WALL LIGHT



TALA-S1

2000.-

W 30x60 mm. D 85 mm.



LED 1x3W 165lm

3000K

IP 65



Black

LED Driver Included

Aluminium body

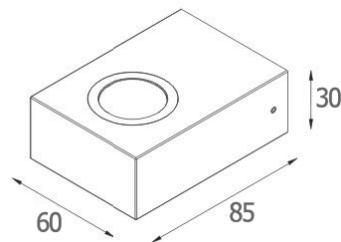

TALA-S2

2400.-

DIA 60x30 mm. D 85 mm.



LED 2x1W 2x85lm

3000K

IP 65



Black

LED Driver Included

Aluminium body

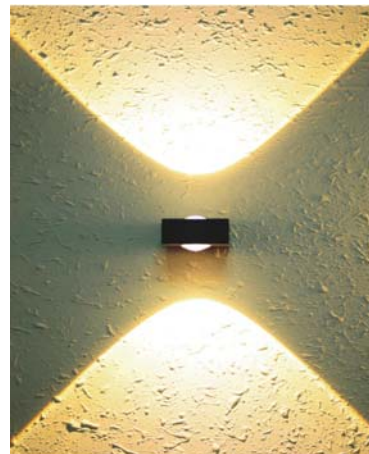
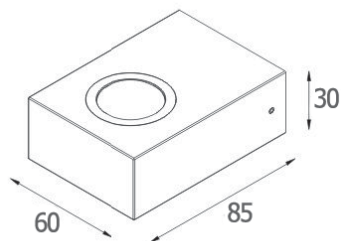

WALL LIGHT



WEBB-G9

1200.-

DIA 90x95 mm. D 90 mm.



1x G9 MAX. 40W

IP 54



Black / Grey

Aluminium body

Clear glass cover

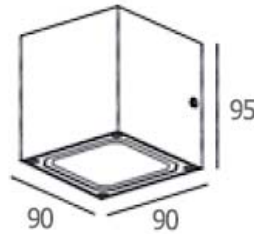

TAG-2S

3250.-

DIA 100x136 mm. D 56 mm.



LED 2x6W 2x270lm



3000K

IP 65



Black / Grey

LED Driver Included

Aluminium body

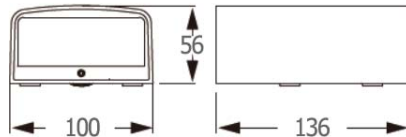

WALL LIGHT



RAMON

3000.-

DIA 95x100 mm. D 60 mm.

 **LED 3x1W 368lm**

 3000K **IP 65**

- Black
- LED Driver Included
- Aluminium body
- Clear glass cover

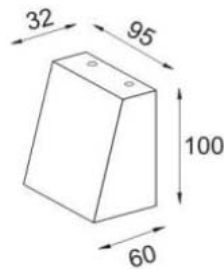

VERON

2000.-

DIA 65x88 mm. D 40 mm.

 **LED 1x3W 270lm**

 3000K **IP 54**

- ● Black / Grey
- LED Driver Included
- Aluminium body
- Clear glass cover

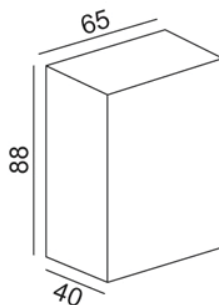

WALL LIGHT

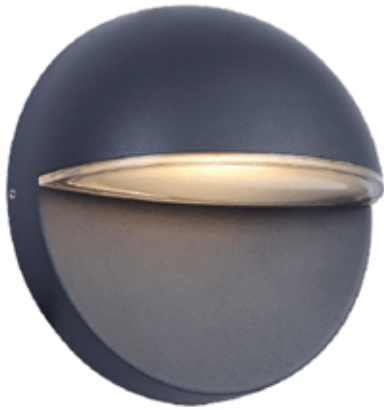

PRIVE

1800.-

DIA 190 mm. D 82.5 mm.

LED 10W 499lm



3000K

IP 54

- Black
- LED Driver Included
- Aluminium body
- Clear glass cover

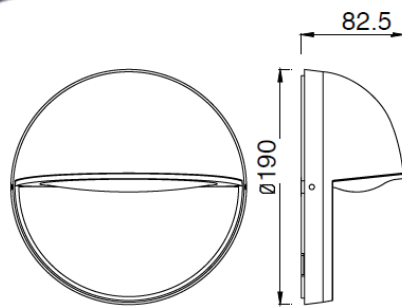

GRACE

2750.-

DIA 145x240 mm. D 100 mm.



LED 12W 1080lm



3000K

IP 54

- Black
- LED Driver Included
- Aluminium body
- Clear glass cover

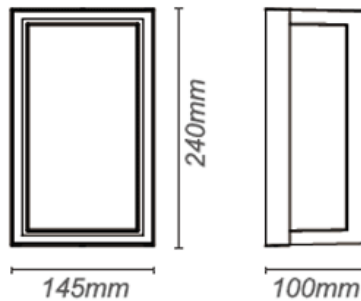

WALL LIGHT



EVA

2000.-

DIA 80x105 mm. D 100 mm.



LED 5W 400lm

3000K

IP 54



Black

LED Driver Included

Aluminium body

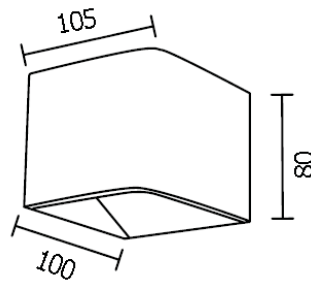

KENNA

2500.-

DIA 90x220 mm. D 80 mm.



LED 6W 375lm

3000K

IP 54



Black

LED Driver Included

Aluminium body

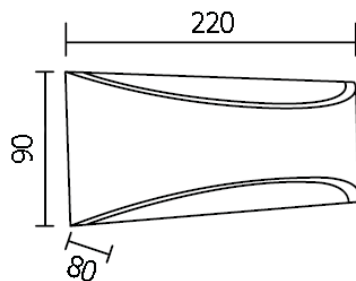
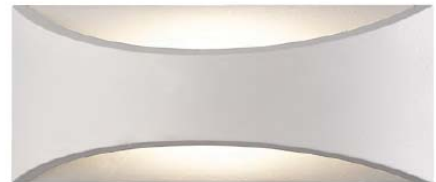

WALL LIGHT



SCOTT **2150.-**

DIA 45x120 mm. D 145 mm.



LED 6W 268lm



3000K

IP 54

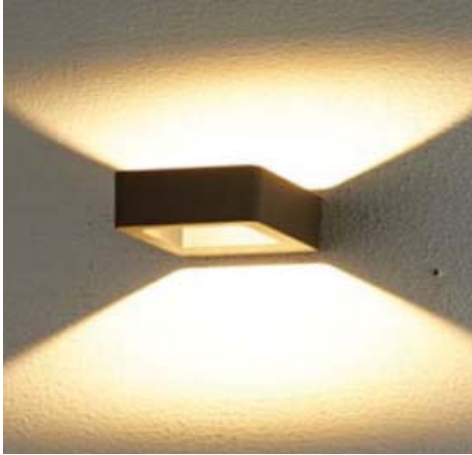

Black

LED Driver Included

Aluminium body

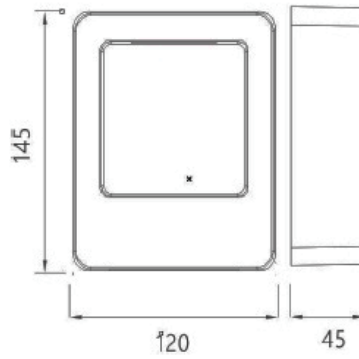

SAM **2000.-**

DIA 100x100 mm. D 100 mm.



LED 2x3W 430lm



3000K

IP 65



Black

LED Driver Included

Aluminium body

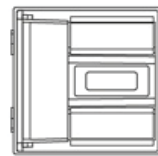
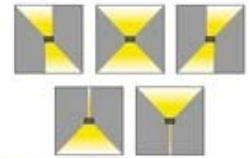

100



100

100

WALL LIGHT



JANIS-R

2000.-

DIA 160 mm. D 100 mm.



LED 10W 560lm



3000K

IP 54



Black

LED Driver Included

Aluminium body

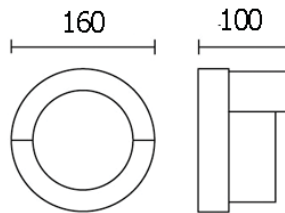

JANIS-S

2000.-

DIA 160x160 mm. D 100 mm.



LED 10W 560lm



3000K

IP 54



Black

LED Driver Included

Aluminium body

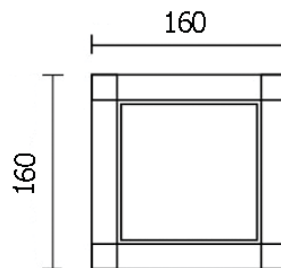

WALL LIGHT



PIMM **3500.-**

DIA 180 mm. D 45 mm.

LED 9W 325lm
3000K **IP 54**

● Black
Aluminium body

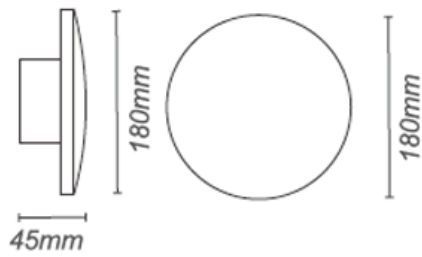

ZEAL **1500.-**

DIA 150x180 mm. D 83 mm.

LED 12W 880lm
3000K **IP 54**

● Black
Aluminium body
PC diffuser

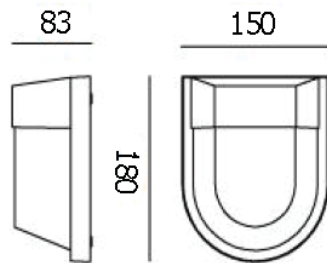



REXTON

1850.-

DIA 110x250 mm. D 103 mm.



1x E27 MAX. LED 13W

IP 54

- ● Black / Grey
- Aluminium body
- PC diffuser

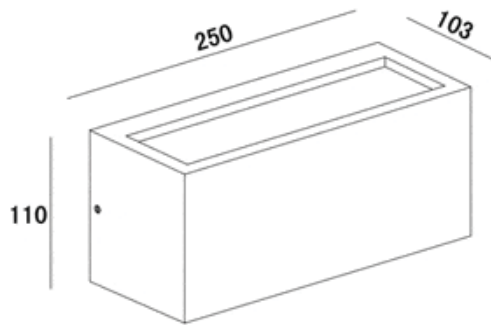

RENZO

1800.-

DIA 165x165 mm. D 171 mm.



1x E27 MAX. LED 13W

IP 54

- Black
- Aluminium body
- PC diffuser

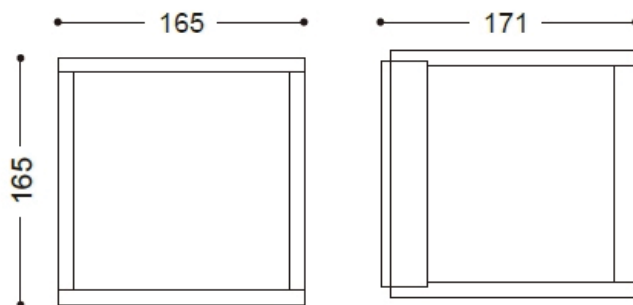

WALL LIGHT



ROMA

1650.-

DIA 145x275 mm. D 102 mm.



1x E27 MAX. LED 13W

IP 54



Black

Aluminium body

PC diffuser

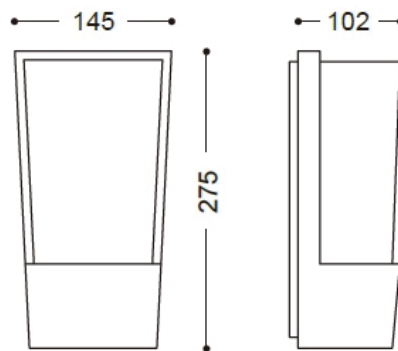

RAMSEY

1800.-

DIA 110x281 mm. D 84 mm.



1x E27 MAX. LED 13W

IP 54



Black

Aluminium body

Frosted glass diffuser

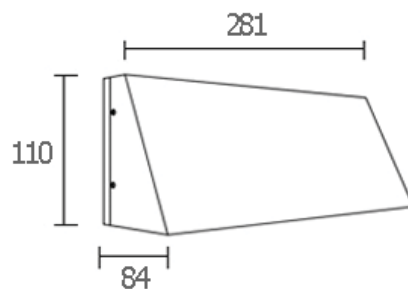

WALL LIGHT



ROCCO

1800.-

DIA 120x245 mm. D 80 mm.



1x E27 MAX. LED 13W

IP 54



Black

Aluminium body

PC diffuser

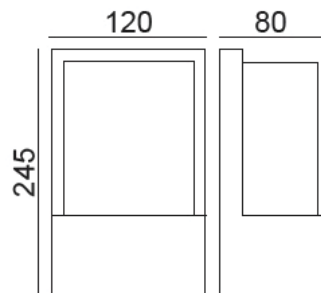

RIO

1500.-

DIA 120x350 mm. D 120 mm.



1x E27 MAX. LED 13W



Black

Aluminium body

PC diffuser

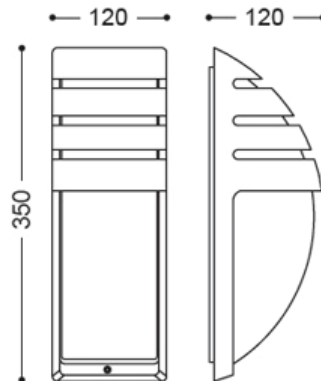

WALL LIGHT



RITA

1500.-

DIA 185x285 mm. D 100 mm.



1x E27 MAX. LED 13W

IP 54

- Black
- Aluminium body
- PC diffuser

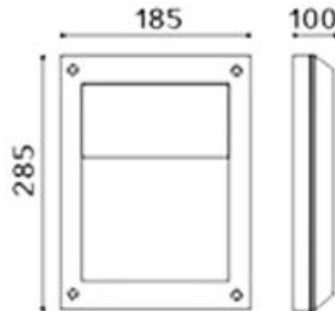

RISTON

1500.-

DIA 185x280 mm. D 100 mm.



1x E27 MAX. LED 13W

IP 54

- Black
- Aluminium body
- PC diffuser

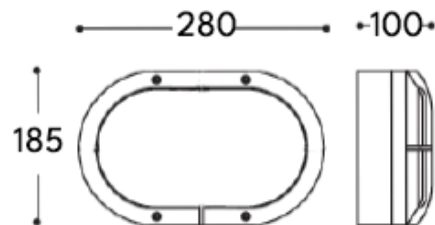

WALL LIGHT



RANDI

1500.-

DIA 120x249 mm. H 135 mm.



2x E27 MAX. LED 13W

IP 54



Black
Aluminium body
PC diffuser

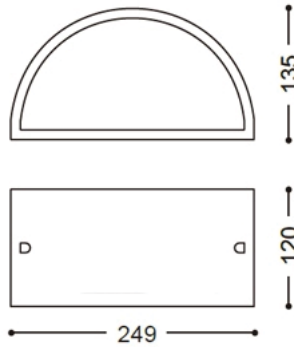

HALLY

1600.-

DIA 70x170 mm D 190 mm.



1x E27 MAX. LED 13W

IP 54



Black
Aluminium body
Frosted glass diffuser

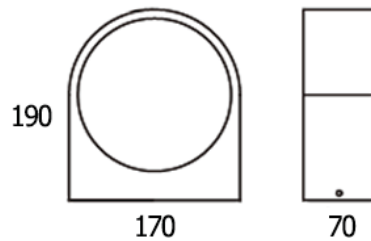
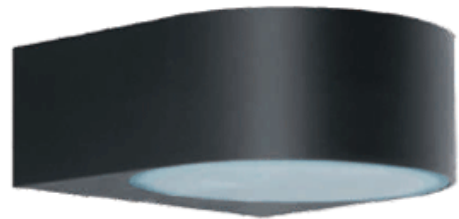

WALL LIGHT



CAMEO

1800.-

DIA 140x260 mm. D 136 mm.



1x E27 MAX. LED 13W

IP 54



Black
Iron body
Clear glass diffuser

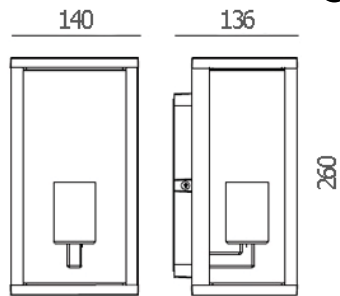

DIOR

1800.-

DIA 170x322 mm. D 182 mm.



1x E27 MAX. LED 13W

IP 54



Black
Iron body
Clear glass diffuser

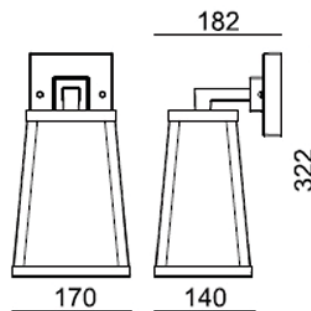

CARTER

2000.-

DIA 143x320 mm. D 186 mm.



1x E27 MAX. LED 13W

IP 54



Black
Aluminium body
Clear glass diffuser

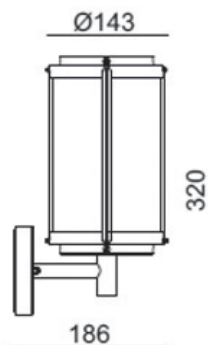



VEGA **2400.-**

DIA 110x250 mm. D 103 mm.



1x E27 MAX. LED 13W

IP 54

- ● Black / Grey
- Aluminium body
- PC diffuser

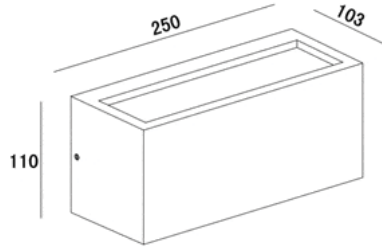

FOX **2400.-**

DIA 100x250 mm. D 110 mm.



1x E27 MAX. LED 13W

IP 54

- ● Black
- Aluminium body
- PC diffuser

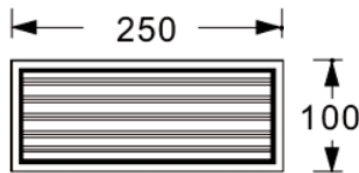
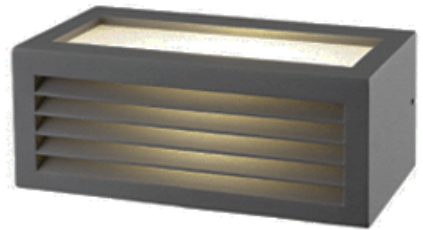

WALL LIGHT



VICK **1800.-**

W 110x280 mm. D 85 mm.



1x E27 MAX. LED 13W

IP 54

- ● Black
- Aluminium body
- PC diffuser

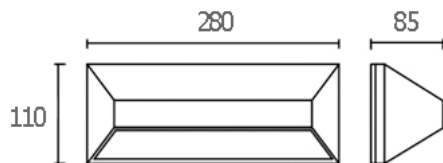



JACEY-R

1800.-

DIA 275 mm. D 80 mm.



2x E27 MAX. LED 13W

IP 54

- Black
- Aluminium body
- PC diffuser

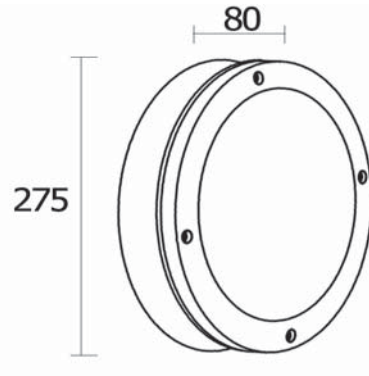

JACEY-S

1800.-

DIA 270x270 mm D 80 mm.



2x E27 MAX. LED 13W

IP 54

- Black
- Aluminium body
- PC diffuser

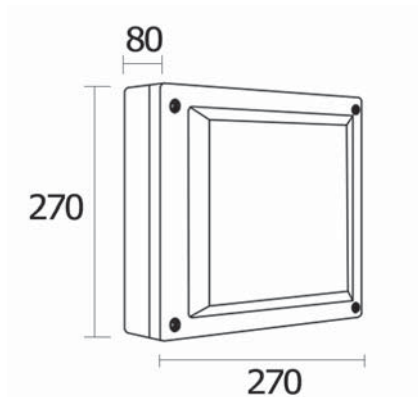

WALL LIGHT



LEON-WR

1350.-

DIA 85x162 mm. D 120 mm.



1x E27 MAX. LED 13W

IP 54

- Black
- Aluminium body
- PC diffuser

LEON-WS

1350.-

DIA 85x85x162 mm D 120 mm.



1x E27 MAX. LED 13W

IP 54

- Black
- Aluminium body
- PC diffuser



WALL LIGHT



KELL

800.-

DIA 163x282 mm. D 109 mm.



1x E27 MAX. LED 13W

IP 54



Black/ White

PC body

Frosted glass diffuser

NANA

1500.-

DIA 90x220 mm. D 80 mm.



1x E27 MAX. LED 13W

IP 54



Black

Aluminium body

PC diffuser



RODIO

1200.-

DIA 60*170 mm. D 88 mm.



1x GU10 MAX. 50W

IP 54



Black

Aluminium body

Glass cover



WALL LIGHT



REBEL

2500.-

DIA 80x160 mm. D 70 mm.

LED 6W 600lm



3000K

IP 54

- Black
- LED Driver Included
- Aluminium body
- Adjustable angle

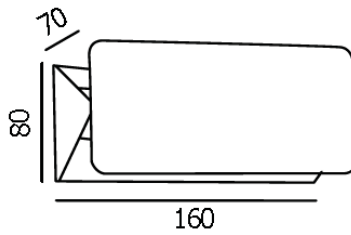

RIVA

2000.-

DIA 100x240 mm. D 155 mm.



LED 6W 600lm



3000K

IP 54

- Black
- LED Driver Included
- Aluminium body

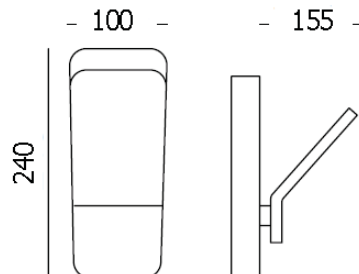

WALL LIGHT



ELLY-1

2000.-

DIA 68x100 mm. D 78 mm.

LED 6W 490lm

3000K **IP 54**

- Black
- LED Driver Included
- Aluminium body
- Clear glass cover

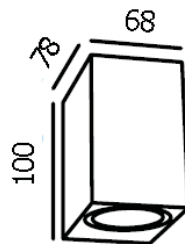

ELLY-2

3500.-

DIA 68x160 mm. D 78 mm.

LED 2x6W 2x490lm

3000K **IP 54**

- Black
- LED Driver Included
- Aluminium body
- Clear glass cover

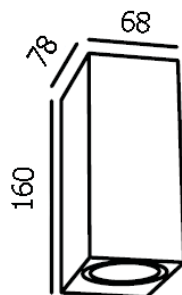

WALL LIGHT



MAKI-R1

1150.-

DIA 90 mm. H 136 mm.



1x GU10 MAX. 50W

IP 54



- Black
Aluminium body
PC diffuser

MAKI-R2

1650 .-

DIA 90 mm. H 212 mm.



2x GU10 MAX. 50W

IP 54

- Black
Aluminium body
PC diffuser



WALL LIGHT



MAKI-S1

1150.-

DIA 85×85 mm. H: 136 mm.



1x GU10 MAX. 50W



Black

Aluminium body

PC diffuser

MAKI-S2

1650.-

DIA 85×85 mm. H 212 mm.



2x GU10 MAX. 50W

IP 54



Black

Aluminium body

PC diffuser



WALL LIGHT



TOLL-R

2750.-

DIA 160x276 mm. D 215 mm.



1x E27 MAX. LED 13W

IP 54

- Black/ White
- Aluminium body
- PC diffuser

TOLL-S

2750.-

DIA 145x145x276 mm. D 215 mm.



1x E27 MAX. LED 13W

IP 54

- Black
- Aluminium body
- PC diffuser



WALL LIGHT

CATT

2750.-

DIA 90x90x200 mm. D 125 mm.



LED 9W 455lm

3000K

IP 54

- Black
- Aluminium body
- PC diffuser

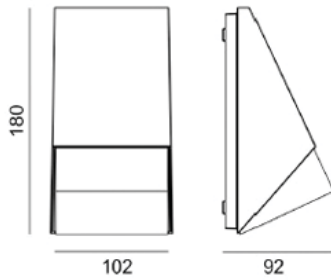

GLATO

2000.-

DIA 102x180 mm. D 92 mm.



1x GU10 MAX. 50W

IP 54



Black

Aluminium body

PC diffuser

GLENN

1350.-

DIA 68x140 mm. D 69 mm.



1x GU10 MAX. 50W

IP 54



Black

Aluminium body

Clear glass cover

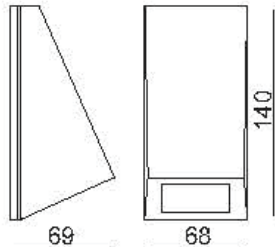

LINA

2000.-

DIA 75x192 mm. D 97 mm.



LED 10W 650lm

3000K

IP 54



Black

Aluminium body

Clear glass cover

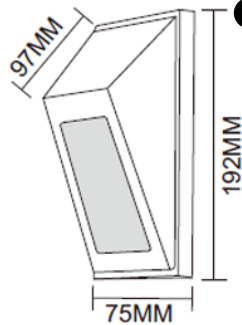

WALL LIGHT

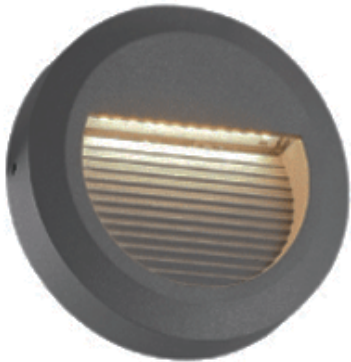

GALLY-R

1000.-

DIA 110 mm. D 26 mm.

 **LED 2W 120lm**
 3000K

IP 54

-  Surface mounted type
Black/ Grey
LED Driver Included
Aluminium body

GALLY-S

1000.-

DIA 100x100 mm. D 26 mm.

 **LED 2W 120lm**
 3000K

IP 54

-  Surface mounted type
Black/ Grey
LED Driver Included
Aluminium body



GALLY-SL

1200.-

DIA 60x150 mm. D 28 mm.

 **LED 3W 185lm**
 3000K

IP 54

-  Surface mounted type
Black/ Grey
LED Driver Included
Aluminium body



WALL LIGHT



STEP-R

1500.-

DIA 110 mm. D 25 mm.



LED 4W 160lm



3000K

IP 54



Surface mounted type

Black

LED Driver Included

Aluminium body

STEP-S

1500.-

DIA 105x105 mm. D 24 mm.



LED 4W 160lm



3000K

IP 54



Surface mounted type

Black

LED Driver Included

Aluminium body



WALL LIGHT



MONA-R

1200.-

DIA 95 mm. D 18 mm.



LED 3W 225lm



3000K

IP 65

- Surface mounted type
- Black
- LED Driver Included
- Aluminium body

MONA-S

1200.-

DIA 90x90 mm. D 18 mm.



LED 3W 225lm



3000K

IP 65

- Surface mounted type
- Black
- LED Driver Included
- Aluminium body



WALL LIGHT



HANA-A

1200.-

DIA 125x125 mm. D 27 mm.



LED 3W 250lm



3000K

IP 54

- Surface mounted type
- Dark grey
- LED Driver Included
- ABS body

HANA-B

1200.-

DIA 125x125 mm. D 27 mm.



LED 1.5W 145lm



3000K

IP 54

- Surface mounted type
- Dark grey
- LED Driver Included
- ABS body



WALL LIGHT



HANA-C

1200.-

DIA 80x230 mm. D 27 mm.



LED 1W 85lm



3000K

IP 54



Surface mounted type

Dark grey

LED Driver Included

ABS body

HANA-D

1800.-

DIA 230x80 mm. D 27 mm.



LED 3W 180lm



3000K

IP 54



Surface mounted type

Dark grey

LED Driver Included

ABS body



WALL LIGHT

A 5x4 grid of squares. The top row is white, the second row is light blue, the third row is medium blue, the fourth row is dark blue, and the bottom row is the darkest blue. The text 'BOLLARD LIGHT' is written in white, bold, italicized capital letters at the bottom of the grid.

BOLLARD LIGHT



DALLTON-RS

2000.-

DIA 90 mm. H 200 mm.



LED 6W 490lm

3000K

IP 54

- Black
LED Driver Included
Aluminium body

DALLTON-RM

4000.-

DIA 90 mm. H 650 mm.



LED 6W 550lm

3000K

IP 54

- Black
LED Driver Included
Aluminium body



DALLTON-RL

4400.-

DIA 108 mm. H 600 mm.



LED 10W 955lm

3000K

IP 54

- Black
LED Driver Included
Aluminium body

BOLLARD LIGHT





DALLTON-S

2000.-

DIA 105x105 mm. H 195 mm.



LED 6W 490lm



3000K

IP 65



Black

LED Driver Included

Aluminium body

DALLTON-M

4400.-

DIA 105x105 mm. H 600 mm.



LED 10W 890lm



3000K

IP 65



Black

LED Driver Included

Aluminium body



BOLLARD LIGHT



DAVE

4950.-

DIA 80x120 mm. H 650 mm.



LED 6W 267lm



3000K

IP 54



Black

LED Driver Included
Aluminium body

MANCO

4400.-

DIA 71x131 mm. H 650 mm.



LED 3x3W 645lm



3000K

IP 54



Black

LED Driver Included
Aluminium body



BOLLARD LIGHT



STAND-1

4500.-

DIA 100x135 mm. H 650 mm.



LED 7W 560lm



3000K

IP 54



Black

LED Driver Included

Aluminium body

STAND-2

5500.-

DIA 100x235 mm. H 650 mm.



LED 2x7W 1120lm



3000K

IP 65



Black

LED Driver Included

Aluminium body



BOLLARD LIGHT



DAREN

4250.-

DIA 48x150 mm. H 600 mm.



LED 5W 160lm



3000K

IP 55



Black
LED Driver Included
Aluminium body

DAYSON

5000.-

DIA 140 mm. H 600 mm.



LED 7.2W 780lm



3000K

IP 65



Black
LED Driver Included
Aluminium body



BOLLARD LIGHT



LOOP

5000.-

DIA 53x160 mm. H 600 mm.



LED 10W 740lm



3000K

IP 54



Black

LED Driver Included

Aluminium body

LAREN

4500.-

DIA 45x120 mm. H 650 mm.

LED 7W 290lm



3000K

IP 54



Black

LED Driver Included

Aluminium body



BOLLARD LIGHT



ROBBY

5350.-

DIA 80x120 mm. H 650 mm.



LED 10W 515lm



3000K

IP 54



Black

LED Driver Included

Aluminium body

HELEN

5150.-

DIA 55x160 mm. H 600 mm.



LED 6W 465lm



3000K

IP 54



Black

LED Driver Included

Aluminium body



BOLLARD LIGHT



ESTER

4950.-

DIA 120x120 mm. H 600 mm.



LED 10W 655lm



3000K

IP 54



Black

LED Driver Included

Aluminium body

DILAN

6000.-

DIA 118 mm. H 800 mm.



LED 10W 626lm



3000K

IP 65



Black

LED Driver Included

Aluminium body



BOLLARD LIGHT



KORO-S

3950.-

DIA 180x180 mm. H 275 mm.



LED 12W 936lm

3000K

IP 54



Black

LED Driver Included
Aluminium body

KORO-M

5500.-

DIA 180x180 mm. H 800 mm.



LED 12W 936lm

3000K

IP 54



Black

LED Driver Included
Aluminium body



BOLLARD LIGHT



RAPPER-S

3500.-

DIA 180x180 mm. H 275 mm.



LED 12W 936lm

3000K

IP 54



Black

LED Driver Included

Aluminium body

RAPPER-M

5000.-

DIA 180x180 mm. H 800 mm.



LED 12W 936lm

3000K

IP 54



Black

LED Driver Included

Aluminium body



BOLLARD LIGHT



DELTA

4800.-

DIA 130x130 mm. H 1000 mm.



1x E27 Max. 60W

IP 54

- Black
Aluminium body
PC Diffuser

DEEGAN

4400.-

DIA 140 mm. H 1000 mm.



1x E27 Max. 60W

IP 54

- Black
Aluminium body
PC Diffuser



BOLLARD LIGHT



DECON

4800.-

DIA 130x130 mm. H 1000 mm.



1x E27 Max. 60W

IP 54

- Black
Aluminium body
PC Diffuser

DELCO

4400.-

DIA 140 mm. H 1000 mm.



1x E27 Max. 60W

IP 54

- Black
Aluminium body
PC Diffuser



BOLLARD LIGHT



DAGON-S

2500.-

DIA 100x100 mm. H 600 mm.



1x E27 Max. 60W

IP 54

- Black
Aluminium body
PC Diffuser

DAGON-R

2500.-

DIA 110 mm. H 600 mm.



1x E27 Max. 60W

IP 54

- Black
Aluminium body
PC Diffuser



BOLLARD LIGHT



MONO

5000.-

DIA 45x100 mm. H 750 mm.



LED 12W 640lm



3000K

IP 54



Black

LED Driver Included

Aluminium body

GIGA

3500.-

DIA 70x150 mm. H 800 mm.



1x GU10 Max. 50W

IP 54



Black

Aluminium body

PC Diffuser



BOLLARD LIGHT



MIGA

4950.-

DIA 120 mm. H 600 mm.



1x E27 Max. 60W

IP 54

- Black
Aluminium body
PC Diffuser

POLY-S

3500.-

DIA 120 mm. H 650 mm.



1x E27 Max. 60W

IP 54

- Black
Aluminium body
PC Diffuser



BOLLARD LIGHT



CARLA-FS

4000.-

DIA 145x145 mm. H 650 mm.



1x E27 Max. 60W

IP 54

- Black
- Aluminium body
- PC Diffuser

CARLA-FR

4000.-

DIA 160 mm. H 650 mm.



1x E27 Max. 60W

IP 54

- Black
- Aluminium body
- PC Diffuser



BOLLARD LIGHT



LEON-R

1800.-

DIA 85 mm. H 600 mm.



1x E27 Max. 60W

IP 54

- Black
Aluminium body
PC Diffuser

LEON-S

1800.-

DIA 85x85 mm. H 600 mm.



1x E27 Max. 60W

IP 54

- Black
Aluminium body
PC Diffuser



BOLLARD LIGHT



CONE

4000.-

DIA 158 mm. H 600 mm.



1x E27 Max. 60W

IP 54

- Black
Aluminium body
PC Diffuser

LISA

3000.-

DIA 120x150 mm. H 600 mm.



1x E27 Max. 60W

IP 54

- Black
Aluminium body
PC Diffuser



BOLLARD LIGHT



MAY

5000.-

DIA 55x160 mm. H 600 mm.



LED 7W 620lm



3000K

IP 54



Black

LED Driver Included

Aluminium body

JIRO

5150.-

DIA 80x120 mm. H 650 mm.



LED 10W 755lm



3000K

IP 65



Black

LED Driver Included

Aluminium body



BOLLARD LIGHT

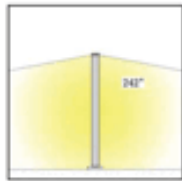

JEDI

4500.-

DIA 95x150 mm. H 700 mm.



LED 12W 470lm



3000K

IP 54



Black

LED Driver Included

Aluminium body

MARON

5200.-

DIA 120 mm. H 600 mm.



LED 12W 455lm



3000K

IP 54



Black

LED Driver Included

Aluminium body



BOLLARD LIGHT



TON

5000.-

DIA 160 mm. H 650 mm.



LED 10W 447lm

3000K

IP 65



Black

LED Driver Included
Aluminium body

ELVA

4000.-

DIA 120 mm. H 1200 mm.



2x T8 Max. 60W

IP 65



Black

Aluminium body
PC Diffuser



BOLLARD LIGHT



ARDEN-R

4150.-

DIA 90 mm. H 650 mm.



LED 9W 455lm



3000K

IP 65

- Black
Aluminium body
PC Diffuser

ARDEN-S

4150.-

DIA 85x85 mm. H 650 mm.



LED 9W 455lm



3000K

IP 65

- Black
Aluminium body
PC Diffuser



BOLLARD LIGHT



CURVE

4000.-

DIA 120 mm. H 650 mm.



LED 10W 348lm



3000K

IP 65



Black

LED Driver Included
Aluminium body

PRAYA

5000.-

DIA 146 mm. H 600 mm.



LED 8W 780lm



3000K

IP 65



Black

Aluminium body
PC Diffuser



BOLLARD LIGHT



MARCA

5000.-

DIA 120 mm. H 630 mm.



LED 7.2W 626lm



3000K

IP 65



Black
LED Driver Included
Aluminium body

DONE

3500.-

DIA 65x390 mm. H 800 mm.



1x E27 Max. 60W

IP 54



Black
Aluminium body
PC Diffuser



BOLLARD LIGHT



CHER

3500.-

DIA 30 mm. H 600 mm.



LED 5W 450lm



3000K

IP 54



Black

LED Driver Included
Aluminium body

JAY

3500.-

DIA 70x120 mm. H 300 mm.



LED 7W 520lm



3000K

IP 54



Black

LED Driver Included
Aluminium body



BOLLARD LIGHT



HOME-S

2500.-

DIA 178 mm. H 510 mm.



LED 12W 936lm



3000K

IP 54



Black

LED Driver Included

Aluminium body

HOME-M

2750.-

DIA 178 mm. H 790 mm.



LED 12W 936lm



3000K

IP 54



Black

LED Driver Included

Aluminium body



BOLLARD LIGHT



FLAME-S

2500.-

DIA 240 mm. H 520 mm.



LED 12W 936lm



3000K

IP 54



Black

LED Driver Included

Aluminium body

FLAME-M

2750.-

DIA 240 mm. H 780 mm.



LED 12W 936lm



3000K

IP 54



Black

LED Driver Included

Aluminium body



BOLLARD LIGHT



ZELL-FR

4250.-

DIA 160 mm. H 500 mm.



1x E27 Max. 60W

IP 54

- Black
Aluminium body
PC Diffuser

ZELL-FS

4250.-

DIA 145x145 mm. H 500 mm.



1x E27 Max. 60W

IP 54

- Black
Aluminium body
PC Diffuser



BOLLARD LIGHT



DEVIN-S

2100.-

DIA 160x160 mm. H 190 mm.



1x E27 Max. 60W

IP 54

- Black
Aluminium body
PC Diffuser

DEVIN-M

2800.-

DIA 220x220 mm. H 270 mm.



1x E27 Max. 60W

IP 54

- Black
Aluminium body
PC Diffuser



BOLLARD LIGHT



CARLA-S

2200.-

DIA 145x145 mm. H 220 mm.



1x E27 Max. 60W

IP 54

- Black
Aluminium body
PC Diffuser

CARLA-R

2200.-

DIA 160 mm. H 220 mm.



1x E27 Max. 60W

IP 54

- Black
Aluminium body
PC Diffuser



BOLLARD LIGHT



SAMMY-S

2500.-

DIA 170x170 mm. H 210 mm.



1x E27 Max. 60W

IP 54

- Black
Aluminium body
PC Diffuser

SAMMY-M

3000.-

DIA 227x227 mm. H 255 mm.



1x E27 Max. 60W

IP 54

- Black
Aluminium body
PC Diffuser



BOLLARD LIGHT



RINA-R

3000.-

DIA 150 mm. H 140 mm.



LED 7W 392lm

3000K

IP 54



Black

LED Driver Included

Aluminium body

RINA-S

3000.-

DIA 156x156 mm. H 140 mm.



LED 7W 392lm

3000K

IP 54



Black

LED Driver Included

Aluminium body



BOLLARD LIGHT



PARRY

2800.-

DIA 130 mm. H 170 mm.



LED 12W 570lm



3000K

IP 65

- Black
LED Driver Included
Aluminium body

LORA

2150.-

DIA 194x194 mm. H 265 mm.



1x E27 Max. 60W

IP 54

- Black
Aluminium body
PC Diffuser



GAMMA

1500.-

DIA 120x120 mm. H 220 mm.



1x E27 Max. 60W

IP 54

- Black
Aluminium body
PC Diffuser

BOLLARD LIGHT



LEON-XR

1500.-

DIA 85 mm. H 300 mm.



1x E27 Max. 60W

IP 54

- Black
Aluminium body
PC Diffuser

LEON-XS

1500.-

DIA 85x85 mm. H 300 mm.



1x E27 Max. 60W

IP 54

- Black
Aluminium body
PC Diffuser



BOLLARD LIGHT



ZELL-BR

2750.-

DIA 160 mm. H 220 mm.



1x E27 Max. 60W

IP 54

- Black
Aluminium body
PC Diffuser

ZELL-BS

2750.-

DIA 145x145 mm. H 220 mm.



1x E27 Max. 60W

IP 54

- Black
Aluminium body
PC Diffuser



BOLLARD LIGHT



SEVEN

27500.-

DIA 80x120x800 mm. H 3000 mm.



LED 30W 2717lm



3000K

IP 65



Black
LED Driver Included
Aluminium body
J-bolt included

STAR

18500.-

DIA 365 mm. H 2500 mm.



LED 30W 2087lm



3000K

IP 65



Black
Aluminium body
PC Diffuser
J-bolt included



BOLLARD LIGHT



ZINO-R

22500.-

DIA 160 mm. H 3000 mm.



LED 25W 2025lm



3000K

IP 65



Black

LED Driver Included

Aluminium body

J-bolt included

RANCE

21000.-

DIA 160 mm. H 3000 mm.



3x T8 Max. 100W

IP 65



Black

Aluminium body

PC Diffuser

J-bolt included



BOLLARD LIGHT



SPOTLIGHT



SPOT-S

2000.-

DIA 42 mm. H 96 mm.

 220V 3W 130lm
 30° 3000K

IP 65

- Black
- LED Driver Included
- Aluminium body
- Clear glass cover
- Accessories : Tree strap

KYLER

2000.-

DIA 105 mm. H 185 mm.

 220V 12W 950lm
 30° 3000K

IP 65

- Black
- LED Driver Included
- Aluminium body
- Clear glass cover



SPOTLIGHT



EMMA-S

1150.-

DIA 47 mm. H 84 mm.

 220V 5W 435lm
 24° 3000K



IP 65

-  Black
- LED Driver Included
- Aluminium body
- Clear glass cover
- Accessories : Tree strap

EMMA-M

1750.-

DIA 60 mm. H 105 mm.

 220V 12W 996lm
 24° 3000K

IP 65



-  Black
- LED Driver Included
- Aluminium body
- Clear glass cover
- Accessories : Tree strap



EMMA-L

2300.-

DIA 80 mm. H 135 mm.

 220V 18W 1494lm
 24° 3000K

IP 65

-  Black
- LED Driver Included
- Aluminium body
- Clear glass cover
- Accessories : Tree strap

SPOTLIGHT





ALLEN-S

2250.-

DIA 63x109 mm. H 143 mm.

 220V 10W 810lm
 36° 3000K



IP 65

- Black
- LED Driver Included
- Aluminium body
- Clear glass cover
- Accessories : Tree strap

ALLEN-M

2850.-

DIA 80x180 mm. H 162 mm.

 220V 15W 1215lm
 36° 3000K

IP 65



- Black
- LED Driver Included
- Aluminium body
- Clear glass cover
- Accessories : Tree strap



ALLEN-L

3250.-

DIA 80x180 mm. H 162 mm.

 220V 20W 1620lm
 36° 3000K

IP 65

- Black
- LED Driver Included
- Aluminium body
- Clear glass cover
- Accessories : Tree strap

SPOTLIGHT



KEELAN-S

3500.-

DIA 67 mm. H 175 mm.



220V 7W 588lm



3000K

IP 65

- Black
- LED Driver Included
- Aluminium body
- Clear glass cover
- Accessories : Tree strap

KEELAN-M

4350.-

DIA 80 mm. H 205 mm.



220V 13W 1170lm



3000K

IP 65

- Black
- LED Driver Included
- Aluminium body
- Clear glass cover



SPOTLIGHT



DOLO

2500.-

DIA 80x80 mm. H 58 mm.



220V 8W 588lm



3000K

IP 65



Black

LED Driver Included

Aluminium body

Clear glass cover

Accessories : Tree strap

KURTIS

1950.-

DIA 80x80 mm. H 70 mm.



220V 6W 480lm

55° 3000K

IP 65



Black

LED Driver Included

Aluminium body

Clear glass cover

Accessories : Tree strap



SPOTLIGHT



PINTA-S

2750.-

DIA 66x72 mm. H 93 mm.



24Vdc 9W 639lm

15° 30° 45° 60°

IP 66

3000K, 4000K, 6000K

- Black/ Grey
- LED Driver Included
- Aluminium body
- Clear glass cover
- Use with switching power supply 24Vdc
- Accessories : Tree strap

PINTA-M

4750.-

DIA 114x116 mm. H 157 mm.



24Vdc 20W 1420lm

15° 30° 45° 60°

IP 66

3000K, 4000K, 6000K

- Black/ Grey
- LED Driver Included
- Aluminium body
- Clear glass cover
- Use with switching power supply 24Vdc
- Accessories : Tree strap



PINTA-L

6750.-

DIA 112x150 mm. H 208 mm.



24Vdc 36W 2556lm

15° 30° 45° 60°

IP 66

3000K, 4000K, 6000K

- Black/ Grey
- LED Driver Included
- Aluminium body
- Clear glass cover
- Use with switching power supply 24Vdc
- Accessories : Tree strap

SPOTLIGHT



COOPER-S

3800.-

DIA 91x91 mm. H 135 mm.



220V 10W 782lm



25° 3000K

IP 66

- Black
- LED Driver Included
- Aluminium body
- Clear glass cover
- Accessories : Tree strap

COOPER-M

7500.-

DIA 158x158 mm. H 212 mm.



220V 24W 2263lm

25° 3000K

IP 66

- Black
- LED Driver Included
- Aluminium body
- Clear glass cover
- Accessories : Tree strap



SPOTLIGHT



POLO-S

3000.-

DIA 65x65 mm. H 125 mm.

 220V 8W 615lm
 30° 3000K



IP 65

- Black
- LED Driver Included
- Aluminium body
- Clear glass cover
- Accessories : Tree strap

POLO-M

4250.-

DIA 90x90 mm. H 145 mm.

 220V 18W 1306lm
 30° 3000K

IP 65

- Black
- LED Driver Included
- Aluminium body
- Clear glass cover
- Accessories : Tree strap



SPOTLIGHT



KERRI-B-MR16

1100.-

DIA 58 mm. H 92 mm.



MR16 x1 Max. 50W
12V/ 220V

IP 54

- Black
- Aluminium body
- Clear glass cover
- Accessories : Tree strap, Honeycomb

KERRI-B-GU10

1100.-

DIA 58 mm. H 92 mm.



GU10x1 Max. 50W
220V

IP 54

- Black
- Aluminium body
- Clear glass cover
- Accessories : Tree strap, Honeycomb



SPOTLIGHT



KERRI-S-MR16

1100.-

DIA 58 mm. H 92 mm.

 MR16 x1 Max. 50W
12V/ 220V

IP 54

-  Black
- Aluminium body
- Clear glass cover
- Accessories : Honeycomb

KERRI-S-GU10

1100.-

DIA 58 mm. H 92 mm.

 GU10x1 Max. 50W
220V

IP 54

-  Black
- Aluminium body
- Clear glass cover
- Accessories : Honeycomb



SPOTLIGHT



CHERYL-B-MR16

1200.-

DIA 58 mm. H 175 mm.



MR16 x1 Max. 50W
12V/ 220V

IP 54

- Black
- Aluminium body
- Clear glass cover
- Accessories : Tree strap, Honeycomb

CHERYL-B-GU10

1200.-

DIA 58 mm. H 175 mm.



GU10x1 Max. 50W
220V

IP 54

- Black
- Aluminium body
- Clear glass cover
- Accessories : Tree strap, Honeycomb



SPOTLIGHT



CHERYL-S-MR16

1200.-

DIA 58 mm. H 175 mm.



MR16 x1 Max. 50W
12V/ 220V

IP 54



Black
Aluminium body
Clear glass cover
Accessories : Honeycomb

CHERYL-S-GU10

1200.-

DIA 58 mm. H 175 mm.



GU10x1 Max. 50W
220V

IP 54



Black
Aluminium body
Clear glass cover
Accessories : Honeycomb



SPOTLIGHT



KIRA

1350.-

DIA 73x73 mm. H 135 mm.

 GU10x1 Max. 50W
220V

IP 54

- Black
- Aluminium body
- Clear glass cover
- Accessories : Tree strap

SONIC

1650.-

DIA 65 mm. H 160 mm.

 GU10x1 Max. 50W
220V

IP 65

- Black
- Aluminium body
- Clear glass cover



SPOTLIGHT



MELO-B

1350.-

DIA 70 mm. H 125 mm.

 GU10x1 Max. 50W
220V

IP 54

- Black
- Aluminium body
- Clear glass cover
- Accessories : Tree strap

MELO-S

1350.-

DIA 70 mm. H 125 mm.

 GU10x1 Max. 50W
220V

IP 54

- Black
- Aluminium body
- Clear glass cover
- Accessories : Tree strap



SPOTLIGHT



ALLEN-MR16

1850.-

DIA 63x109 mm. H 143 mm.



MR16x1 Max. 50W
12V/ 220V

IP 65

- Black
- Aluminium body
- Clear glass cover
- Accessories : Tree strap

ALLEN-GU10

1850.-

DIA 63x109 mm. H 143 mm.



GU10x1 Max. 50W
220V

IP 65

- Black
- Aluminium body
- Clear glass cover
- Accessories : Tree strap



SPOTLIGHT

MANNY-MR16

1000.-



DIA 60 mm. H 85 mm. 115 mm. with anti glare

 MR16 x1 Max. 50W
12V/ 220V

IP 54

 Black
Aluminium body
Clear glass cover

MANNY-GU10

1000.-

DIA 60 mm. H 85 mm. 115 mm. with anti glare

 GU10x1 Max. 50W
220V

IP 54

 Black
Aluminium body
Clear glass cover



SPOTLIGHT



IDA

700.-

DIA 98 mm. H 93 mm.



GU10x1 Max. 50W
220V

IP 55

- Black
- Aluminium body
- Clear glass cover
- Accessories : Tree strap

IVY

700.-

DIA 98 mm. H 128 mm.



GU10x1 Max. 50W
220V

IP 55

- Black
- Aluminium body
- Clear glass cover
- Accessories : Tree strap



SPOTLIGHT



LACEY

1000.-

DIA 90 mm. H 150 mm.

 GU10x1 Max. 50W
220V

IP 55

 Black
Aluminium body
Clear glass cover

LADA

1600.-

DIA 110 mm. H 185 mm.

 E27 PAR20x1 Max. 50W
220V

IP 55

 Black
Aluminium body
Clear glass cover



SPOTLIGHT



TRAM-18

5000.-

DIA 43x50 mm. L 1000 mm.



24V 18x1W 1802lm

7° 25° 40° 10°x50°

IP 66



3000K/ 4000K/ 6000K

Grey

Use with switching power supply 24Vdc

Aluminium body

Clear glass cover

TRAM-36

6000.-

DIA 43x50 mm. L 1000 mm.



220V 36x1W 3587lm

7° 25° 40° 10°x50°

IP 66



3000K/ 4000K/ 6000K

Grey

Use with switching power supply 24Vdc

Aluminium body

Clear glass cover



WALL WASHER



10°x40°

FLEX

12000.-

DIA : 320 x 32 x 65 mm. (Per 3Modules)

LED 24V 15W (5W per module)
10°x40° 3000K

IP 54

Black
Aluminium body

FLOW

15000.-

DIA : 523 x 76 x 102 mm. (Per 3Modules)

LED 24V 18W (6W per module)
15°x45° 3000K

IP 66

Black
Aluminium body



15°x45°

FITT

12000.-

DIA : 1200 X Ø37.5 X 55 mm.

LED 24V 45W
20°x40° 3000K

IP 66

Black
Aluminium body

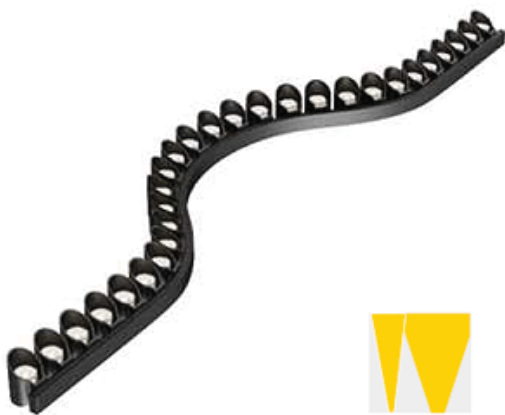

20°x40°

SPOTLIGHT

The image features a 5x4 grid of squares. The top row consists of four squares with a light blue to white gradient. The second row consists of four squares with a light blue to white gradient. The third row consists of four squares with a medium blue to white gradient. The fourth row consists of four squares with a medium blue to white gradient. The bottom row consists of four squares with a dark blue to white gradient. The text 'INGROUND LIGHT' is written in white, bold, italicized capital letters across the bottom row of the grid.

INGROUND LIGHT



ING-R

1800.-

DIA 42 mm. H 63 mm.



CREE CHIP LED 3W 115lm



3000K



Aluminium Cover

Recess Housing Included

LED Driver 700mA Included

Dimmable (0-10V/ Triac) Optional

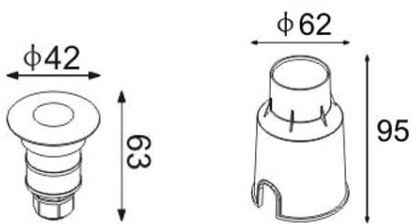

ING-S

1800.-

DIA 42x42 mm. H 63 mm.



CREE CHIP LED 3W 115lm



3000K



Aluminium Cover

Recess Housing Included

LED Driver 700mA Included

Dimmable (0-10V/ Triac) Optional

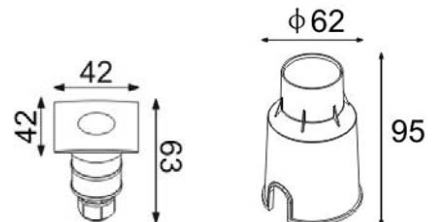

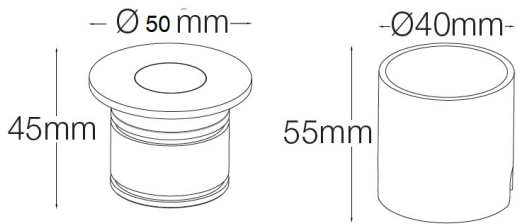

ING-50

2000.-

DIA 50 mm. H 55 mm.



CREE CHIP LED 3W 115lm



3000K 24Vdc



Stainless SUS 316 Cover
Recess Housing Included
Dimmable (0-10V/ Triac) Optional

ING-95

3800.-

DIA 95 mm. H 135 mm.



CREE CHIP LED 10W 912lm



3000K 24Vdc



Stainless SUS 316 Cover
Recess Housing Included
Dimmable (0-10V/ Triac) Optional

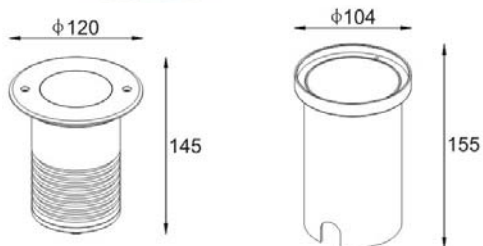
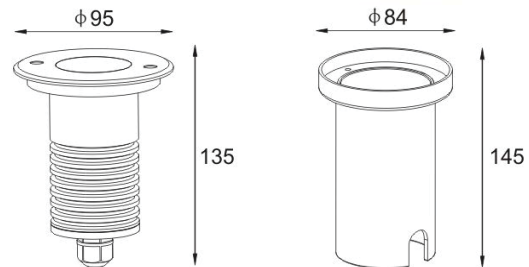

ING-120

5050.-

DIA 120 mm. H 145 mm.



CREE CHIP LED 15W 1320lm



3000K 24Vdc



Stainless SUS 316 Cover
Recess Housing Included
Dimmable (0-10V/ Triac) Optional



MUSH-R1

1800.-

DIA 58.5 mm. H 58 mm.



CREE CHIP LED 3W 115lm



1-WAY LIGHT ● 3000K 24Vdc

IP 67



Aluminium Cover

Recess Housing Included

Dimmable (0-10V/ Triac) Optional

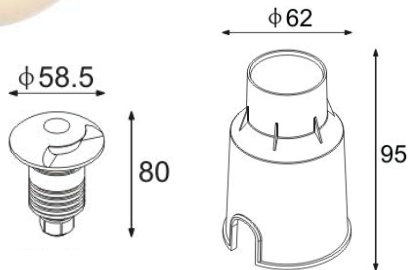

MUSH-R2

1800.-

DIA 58.5 mm. H 58 mm.



CREE CHIP LED 3W 115lm



2-WAY LIGHT ● 3000K 24Vdc

IP 67



Aluminium Cover

Recess Housing Included

Dimmable (0-10V/ Triac) Optional

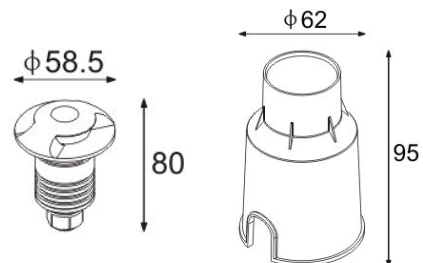

MUSH-R4

1800.-

DIA 58.5 mm. H 58 mm.



CREE CHIP LED 3W 115lm



4-WAY LIGHT ● 3000K 24Vdc

IP 67



Aluminium Cover

Recess Housing Included

Dimmable (0-10V/ Triac) Optional

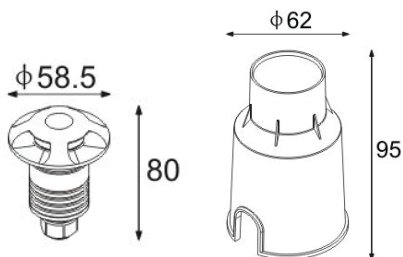

INGROUND LIGHT



ING-SRGB

2950.-

DIA 50 mm. H 80 mm.



EDISON LED 3W 130lm



RGB 24Vdc

IP 67

- Stainless SUS 316 Cover
- Recess Housing Included
- Use with RGB Controller

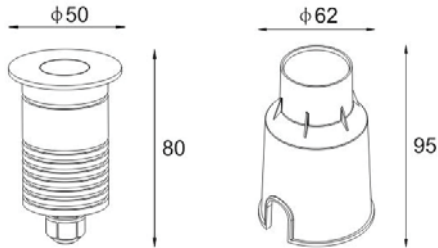

ING-CWW

3500.-

DIA 120 mm. H 94 mm.



CREE CHIP LED 3x2W 320lm



3000K 24Vdc

IP 67

- Stainless SUS 316 Cover
- Recess Housing Included
- Dimmable (0-10V/ Triac) Optional

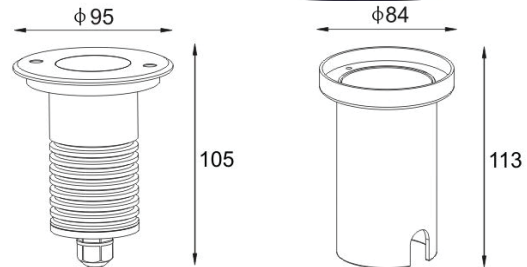

ING-CRGB

5750.-

DIA 58.5 mm. H 58 mm.



EDISON LED RGB 3x3W 295lm



RGB 24Vdc

IP 67

- Stainless SUS 316 Cover
- Recess Housing Included
- Use with RGB Controller

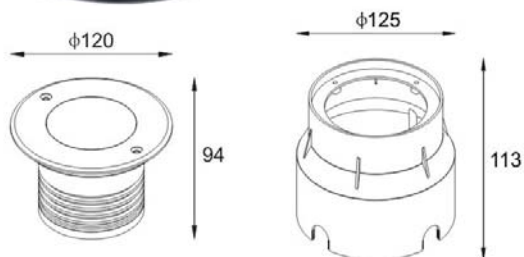

www.speclight.co.th



ING-RMR

1500.-

DIA 100 mm. H 105 mm.



1x MR16 MAX. 50W

IP 67



Stainless SUS 304 Cover
Recess Housing Included

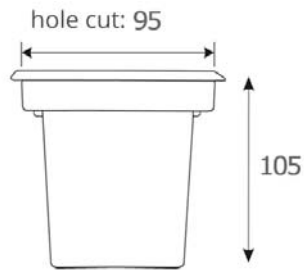
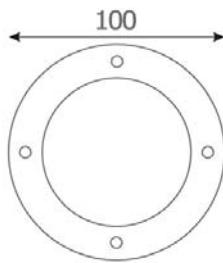

ING-RGU

1500.-

DIA 100 mm. H 105 mm.



1x GU10 MAX. 50W

IP 67



Stainless SUS 304 Cover
Recess Housing Included

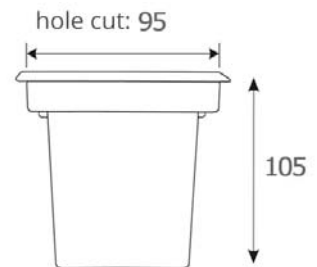
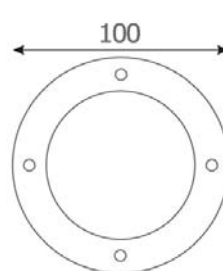



ING-SMR

1500.-

DIA 100x100 mm. H 105 mm.



1x MR16 MAX. 50W

IP 67



Stainless SUS 304 Cover
Recess Housing Included

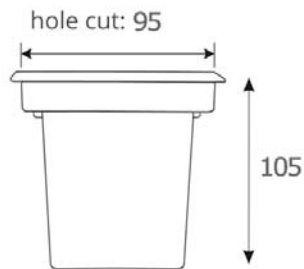
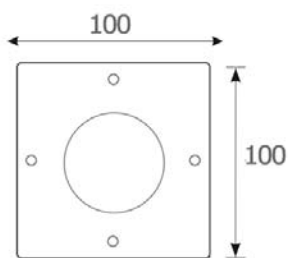

ING-SGU

1500.-

DIA 100x100 mm. H 105 mm.



1x GU10 MAX. 50W

IP 67



Stainless SUS 304 Cover
Recess Housing Included

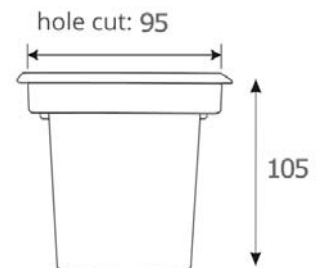
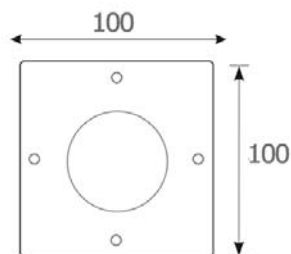

INGROUND LIGHT



ING-ADJ

2500.-

DIA 110 mm. H 147 mm.



1x GU10 MAX. 50W

IP 67

ADJUSTABLE



Stainless SUS 304 Cover
Recess Housing Included

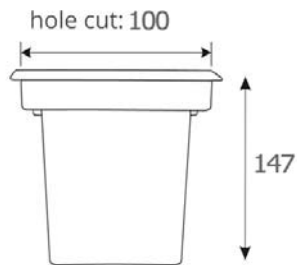
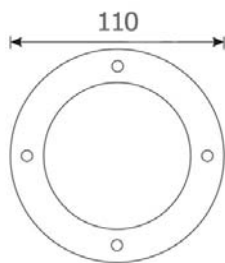

ING-GX53

2000.-

DIA 120 mm. H 70 mm.



1x GX53 MAX. 50W

IP 67



Stainless SUS 304 Cover
Recess Housing Included

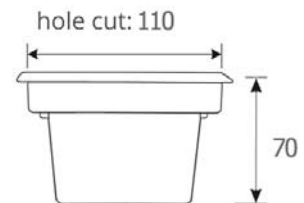
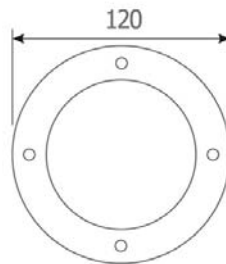

INGROUND LIGHT



RISE-R1

1800.-

DIA 65 mm. H 60 mm.



LED 3W 85lm



1-WAY LIGHT



3000K



IP 65



Aluminium Cover

Recess Housing Included

LED Driver Included

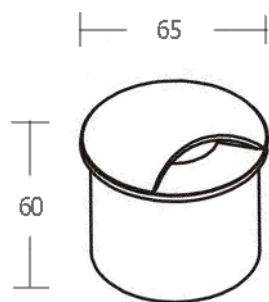

RISE-R2

1800.-

DIA 65 mm. H 60 mm.



LED 3W 85lm



2-WAY LIGHT



3000K



IP 65



Aluminium Cover

Recess Housing Included

LED Driver Included

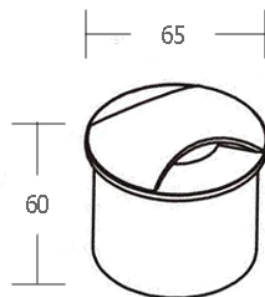

INGROUND LIGHT

A 5x4 grid of squares. The top row is white, the second row is light blue, the third row is medium blue, the fourth row is dark blue, and the bottom row is the darkest blue. The text 'STEP LIGHT' is written in white, bold, italicized capital letters in the bottom right corner of the grid.



STEP LIGHT



STEP-OA

1200.-

DIA 110x110 mm. D 100 mm.

 G4x1 Max. 50W
 Sand black



IP 55

-  Recessed type
Black
Frosted glass cover
Aluminium body
Box installation included

STEP-OB

1200.-

DIA 110x110 mm. D 102 mm.

 G4x1 Max. 50W
 Sand black

IP 55



-  Recessed type
Black
Aluminium body
Box installation included



STEP-OC

1200.-

DIA 110x110 mm. D 102 mm.

 G4x1 Max. 50W
 Sand black

IP 55

-  Recessed type
Black
Aluminium body
Box installation included



STEP LIGHT



STEP-OD

1500.-

DIA 86 mm. D 55 mm.

 **LED 3W 190lm**
 3000K



IP 54

-  Recessed type
- Black
- LED Driver Included
- Aluminium body
- Box installation included

STEP-OE

1500.-

DIA 87x87 mm. D 55 mm.

 **LED 3W 190lm**
 3000K

IP 54



-  Recessed type
- Black
- LED Driver Included
- Aluminium body
- Box installation included



STEP-OF

1500.-

DIA 87x87 mm. D 55 mm.

 **LED 3W 190lm**
 3000K

IP 54

-  Recessed type
- Black/ White
- LED Driver Included
- Aluminium body
- Box installation included



STEP LIGHT



STEP-OK

1500.-

DIA 72x147 mm. D 55 mm.



LED 3W 200lm



3000K

IP 65

- Recessed type
- Black
- LED Driver Included
- Aluminium body
- Box installation included

STEP-OL

1500.-

DIA 75x170 mm. D 53 mm.



LED 5W 370lm



3000K

IP 65

- Recessed type
- Black
- LED Driver Included
- Aluminium body
- Box installation included



STEP LIGHT

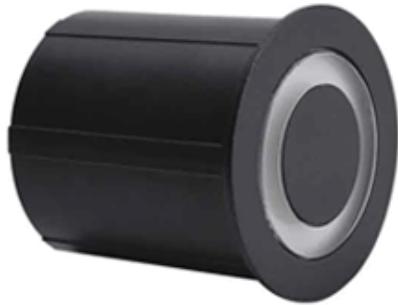

STEP-OM

1000.-

DIA 65 mm. D 50 mm.



LED 3W 115lm



3000K

IP 65

- Recessed type
- Black
- LED Driver Included
- Aluminium body
- Box installation included

STEP-ON

1000.-

DIA 65 mm. D 50 mm.



LED 3W 185lm



3000K

IP 65

- Recessed type
- Black
- LED Driver Included
- Aluminium body
- Box installation included



STEP-OP

1000.-

DIA 65x65 mm. D 70 mm.



LED 3W 145lm



3000K

IP 65

- Recessed type
- Black
- LED Driver Included
- Aluminium body
- Box installation included



STEP LIGHT



STEP-OS

2000.-

DIA 160x160 mm. D 63 mm.



LED 7W 475lm



3000K

IP 65

- Recessed type
- Black
- LED Driver Included
- Aluminium body
- Box installation included

STEP-OT

1200.-

DIA 80x120 mm. D 50 mm.



LED 3W 200lm



3000K

IP 65

- Recessed type
- Black
- LED Driver Included
- Aluminium body
- Box installation included





ROTTY-R

1050.-

DIA 80 mm. D 50 mm.



LED 3W 200lm

3000K

IP 54

- Recessed type
- Black/ Grey
- LED Driver Included
- Aluminium body
- Box installation included

ROTTY-S

1050.-

DIA 90x90 mm. D 55 mm.



LED 2W 135lm

3000K

IP 65

- Recessed type
- Black/ Grey
- LED Driver Included
- Aluminium body
- Box installation included



STEP LIGHT



REEN

1000.-

DIA 85x85 mm. D 53 mm.



LED 2W 200lm



3000K

IP 65

- Recessed type
- Black
- LED Driver Included
- Aluminium body
- Box installation included

HASSEL

2000.-

DIA 50x130 mm. D 60 mm.



LED 5W 350lm



3000K

IP 65

- Recessed type
- Black
- LED Driver Included
- Aluminium body
- Box installation included



STEP LIGHT



SHAY

1200.-

DIA 44x100 mm. D 44 mm.



LED 2W 175lm

3000K

IP 65

- Recessed type
- Black
- LED Driver Included
- Aluminium body
- Box installation included

STEP-OJ

1000.-

DIA 60x105 mm. D 55 mm.



LED 3W 200lm

3000K

IP 65

- Recessed type
- Black
- LED Driver Included
- Aluminium body
- Box installation included



STEP LIGHT

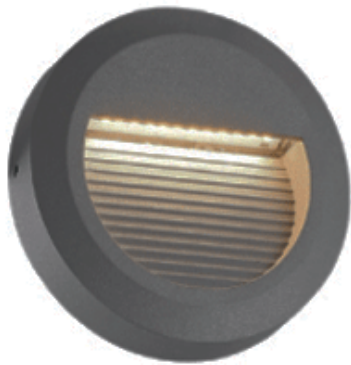

GALLY-R

1000.-

DIA 110 mm. D 26 mm.



LED 2W 120lm

3000K

IP 54

- Surface mounted type
Black/ Grey
LED Driver Included
Aluminium body

GALLY-S

1000.-

DIA 100x100 mm. D 26 mm.



LED 2W 120lm

3000K

IP 54

- Surface mounted type
Black/ Grey
LED Driver Included
Aluminium body



STEP LIGHT



GALLY-SL

1200.-

DIA 60x150 mm. D 28 mm.



LED 3W 185lm

3000K

IP 54



- Surface mounted type
Black/ Grey
LED Driver Included
Aluminium body



STEP-R

1500.-

DIA 110 mm. D 25 mm.

 **LED 4W 160lm**
 3000K

IP 54

-  Surface mounted type
Black
LED Driver Included
Aluminium body

STEP-S

1500.-

DIA 105x105 mm. D 24 mm.

 **LED 4W 160lm**
 3000K

IP 54

-  Surface mounted type
Black
LED Driver Included
Aluminium body



STEP LIGHT



MONA-R

1200.-

DIA 95 mm. D 18 mm.



LED 3W 225lm



3000K

IP 65

- Surface mounted type
- Black
- LED Driver Included
- Aluminium body

MONA-S

1200.-

DIA 90x90 mm. D 18 mm.



LED 3W 225lm



3000K

IP 65

- Surface mounted type
- Black
- LED Driver Included
- Aluminium body



STEP LIGHT



HANA-A

1200.-

DIA 125x125 mm. D 27 mm.



LED 3W 250lm



3000K

IP 54

- Surface mounted type
- Dark grey
- LED Driver Included
- ABS body

HANA-B

1200.-

DIA 125x125 mm. D 27 mm.



LED 1.5W 145lm



3000K

IP 54

- Surface mounted type
- Dark grey
- LED Driver Included
- ABS body



STEP LIGHT



HANA-C

1200.-

DIA 80x230 mm. D 27 mm.



LED 1W 85lm



3000K

IP 54

- Surface mounted type
- Dark grey
- LED Driver Included
- ABS body

HANA-D

1800.-

DIA 230x80 mm. D 27 mm.



LED 3W 180lm



3000K

IP 54

- Surface mounted type
- Dark grey
- LED Driver Included
- ABS body



STEP LIGHT



JENNY

2000.-

DIA 115x115 mm. D 60 mm.



LED 2x2W 200lm



3000K

IP 65

- Recessed type
- Black
- LED Driver Included
- Aluminium body
- Box installation included

LINA

2000.-

DIA 75x192 mm. H 97 mm.



LED 5W 350lm



3000K

IP 54

- Surface mounted type
- Black
- LED Driver Included
- Aluminium body

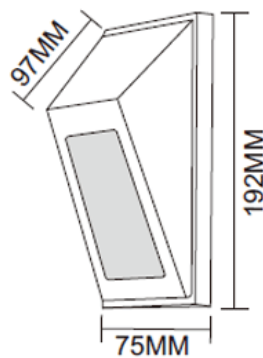

STEP LIGHT



GLATO

2000.-

DIA 102x180 mm. D 92 mm.

1x GU10 MAX. 50W

IP 54

- Surface mounted type
- Black
- Aluminium body
- PC diffuser

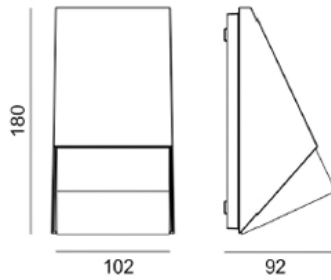

GLENN

1350.-

DIA 68x140 mm. D 69 mm.

1x GU10 MAX. 50W

IP 54

- Surface mounted type
- Black
- Aluminium body
- Clear glass cover

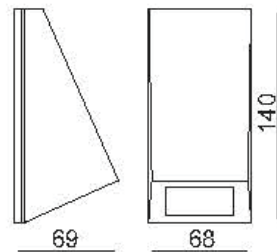

STEP LIGHT

ARINA-A

2000.-

DIA 82x192 D 94 mm.



LED 10W 650lm

3000K

IP 65

- Recessed type
- Black
- LED Driver Included
- Aluminium body
- Box installation included

ARINA-B

2000.-

DIA 82x192 mm. D 101 mm.



LED 10W 650lm

3000K

IP 65

- Recessed type
- Black
- LED Driver Included
- Aluminium body
- Box installation included

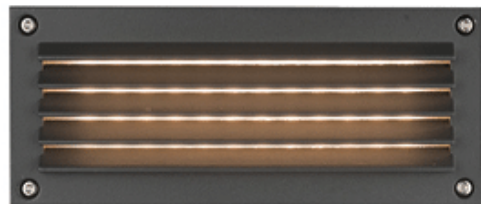

STEP LIGHT



***OUTDOOR
DOWNLIGHT***



NANO-R

2150.-

DIA 90 mm. H 77 mm.



LED COB 10W 843lm
3000K, 4000K
Matt white trim



IP 65

- Adjustable
- Aluminium Body
- Driver included
- Non-Dim
- Dimmable (0-10V/ Triac) Optional

NANO-S

2150.-

DIA 90x90 mm. H 77 mm.



LED COB 10W 843lm
3000K, 4000K
Matt white trim



IP 65

- Adjustable
- Aluminium Body
- Driver included
- Non-Dim
- Dimmable (0-10V/ Triac) Optional



DOWNLIGHT



TITAN

2150.-

DIA 90 mm. H 92 mm.



LED COB 10W 755lm



3000K, 4000K

Matt white/ Matt black/

IP 65



Fixed

Aluminium Body

Driver included

Non-Dim

Dimmable (0-10V/ Triac) Optional

LUCENT

600.-

DIA 85 mm. H 45 mm.



MR16x1/ GU10/ LED Module

Matt white/ Matt black trim

IP 65



Fixed

Aluminium Body

Clear glass cover



HOWELL

1000.-

DIA 100 mm. H 65 mm.



GX53 Max. 50W

Sand black

IP 54



Fixed

Aluminium Body

Frosted glass cover



DOWNLIGHT



HUGO-R

1800.-

DIA 110 mm. H 160 mm.

 E27x1 Max. 60W
Sand black

IP 54

 Fixed
Aluminium Body
Clear glass cover

HUGO-S

1800.-

DIA 110x110 mm. H 160 mm.

 E27x1 Max. 60W
Sand black

IP 54

 Fixed
Aluminium Body
Clear glass cover



DOWNLIGHT



LINDA-R

1500.-

DIA 90 mm. H 95 mm.

 GU10x1 Max.50W
Sand black/ Sand white

IP 65

 Fixed
Aluminium Body
Frosted glass cover

LINDA-S

1500.-

DIA 90x90 mm. H 95 mm.

 GU10x1 Max.50W
Sand black/ Sand white

IP 65

 Fixed
Aluminium Body
Frosted glass cover



DOWNLIGHT



JADEN-R

1500.-

DIA 90 mm. H 120 mm.

 GU10x1 Max.50W
Sand black

IP 54

 Fixed
Aluminium Body
Clear glass cover

JADEN-S

1500.-

DIA 90x90 mm. H 125 mm.

 GU10x1 Max.50W
Sand black

IP 54

 Fixed
Aluminium Body
Clear glass cover



DOWNLIGHT

The image features a 5x4 grid of squares. The top row consists of four squares with a light blue-to-white gradient. The second row consists of four squares with a light blue-to-white gradient. The third row consists of four squares with a medium blue-to-white gradient. The fourth row consists of four squares with a medium blue-to-white gradient. The bottom row consists of four squares with a dark blue-to-white gradient. The text 'UNDERWATER LIGHT' is positioned in the bottom right corner of the grid, in a white, bold, italicized sans-serif font.

***UNDERWATER
LIGHT***

RUW-3WW

3150.-

DIA 50 mm. H 56 mm.



 24Vdc 3W 264lm
 24° 3000K



IP 68

- Stainless steel SUS316
Tempered glass cover
Use with 24Vdc switching power supply
Wire 1m.
Box size Dia 62mm. H 95mm.

RUW-10WW

4950.-

DIA 95 mm. H 80 mm.

 24Vdc 10W 912lm
 23° 3000K

IP 68

- Stainless steel SUS316
Tempered glass cover
Use with 24Vdc switching power supply
Wire 1m.
Box size Dia 84mm. H 113mm.



UNDERWATER



RUW-6WW

4500.-

DIA 120 mm. H 64 mm.



24Vdc 6W 528lm

30° 3000K

IP 68

- Stainless steel SUS316
Tempered glass cover
Use with 24Vdc switching power supply
Wire 1m.
Box size Dia 125mm. H 113mm.

RUW-9RGB

6000.-

DIA 120 mm. H 64 mm.



24Vdc 3x3W 266lm

40° RGB Color change

IP 68

- Stainless steel SUS316
Tempered glass cover
Use with 24Vdc switching power supply
Use with RGB controller
Wire 1m.
Box size Dia 125mm. H 113mm.



UNDERWATER



RUW-14WW

7000.-

DIA 150 mm. H 113 mm.



24Vdc 7x2W 812lm

30° 3000K

IP 68

- Stainless steel SUS316
Tempered glass cover
Use with 24Vdc switching power supply
Wire 1.5m.
Box size Dia 150mm. H 113mm.

RUW-24WW

9500.-

DIA 180 mm. H 113 mm.



24Vdc 12x2W 1410lm

30° 3000K

IP 68

- Stainless steel SUS316
Tempered glass cover
Use with 24Vdc switching power supply
Wire 1.5m.
Box size Dia 180mm. H 113mm.



UNDERWATER



SUW-3WW

3500.-

DIA 49.5 mm. H 50 mm.

 24Vdc 3W 264lm
 40° 3000K



IP 68

- Stainless steel SUS316
Tempered glass cover
Use with 24Vdc switching power supply
Wire 1.5m.

SUW-7WW

4350.-

DIA 80 mm. H 97 mm.

 24Vdc 7W 616lm
 23° 3000K

IP 68

- Stainless steel SUS316
Tempered glass cover
Use with 24Vdc switching power supply
Wire 1.5m.





UNDERWATER

SUW015

4200.-

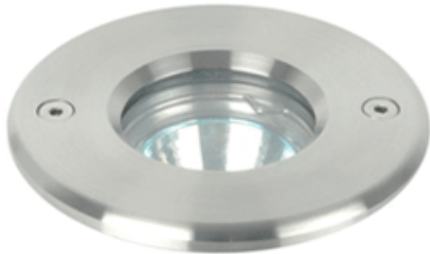
DIA 101 mm. H 123 mm.



 LED MR16x1
Use 12V only

IP 68

- Stainless steel SUS316
Tempered glass cover
Use with 12Vdc switching power supply
Wire 3m.

SUB015

4050.-

DIA 75 mm. H 74 mm.

 LED MR16x1
Use 12V only

IP 68

- Stainless steel SUS316
Tempered glass cover
Use with 12Vdc switching power supply
Wire 3m.



UNDERWATER